

Specifications

- Current rating: 7A AC, DC
- Voltage rating: 300V AC, DC
- Temperature range: -25°C ~ +85°C
- Contact resistance: 7mΩ Max.
- Insulation resistance: 1000MΩ Min.
- Withstanding voltage: 1500V AC/minute
- *Compliant with RoHS and REACH*
- *Meet the HF/Halogen Free, GWT/Glow wire Test (IEC60335-1) request, need to customize*
- *Contact HDGC for details*

Assembly layout

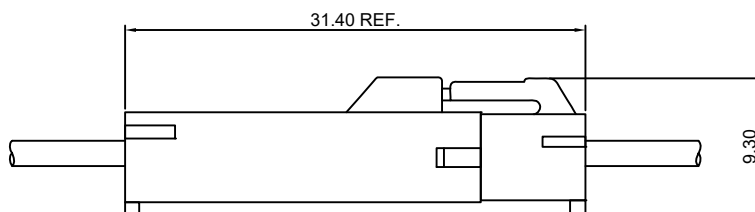



HDGC3967 Series 3.96mm (.156") Pitch Wire to Wire Connector

HDGC3967F-T

3.96mm pitch Crimp Terminal

Reference Informations:

*Used in HDGC3967HF-XP, HDGC3967HF-2x3P series Housing

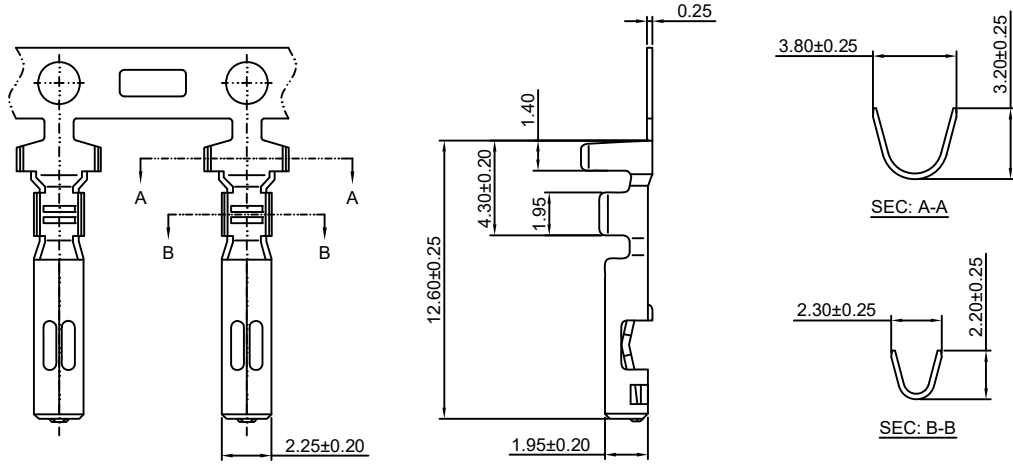

Ordering information & Specifications:

Unit:mm

Part NO.	Wire Range	Insulation O.D.	Material	Finish	Qty/reel
HDGC3967F-TP	AWG#20-#26	2.50mm(max)	Phosphor Bronze	Tin over Nickel	15,000 PCS
HDGC3967F-GP	AWG#20-#26	2.50mm(max)	Phosphor Bronze	Gold over Nickel	15,000 PCS

Optional Gold plating available but MOQ requested

HDGC3967M-T

3.96mm pitch Crimp Terminal

Reference Informations:

*Used in HDGC3967HM-XP, HDGC3967HM-2x3P series Housing

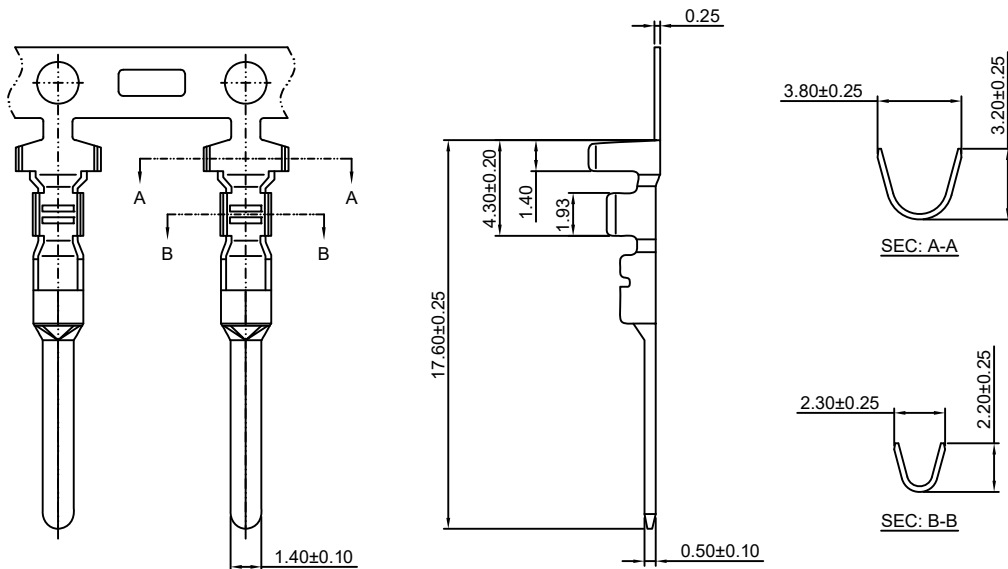

Ordering information & Specifications:

Unit:mm

Part NO.	Wire Range	Insulation O.D.	Material	Finish	Qty/reel
HDGC3967M-TP	AWG#20-#26	2.50mm(max)	Phosphor Bronze	Tin over Nickel	15,000 PCS
HDGC3967M-GP	AWG#20-#26	2.50mm(max)	Phosphor Bronze	Gold over Nickel	15,000 PCS

Optional Gold plating available but MOQ requested



HDGC3967 Series 3.96mm (.156") Pitch Wire to Wire Connector

HDGC3967HF-XP

3.96mm Pitch Housing

Reference Informations:

- *Material:Nylon 66,UL94V-0
- *Suitable HDGC3967F-T series Terminal
- *Mates with HDGC3967HM-XP series Housing
- *Color:White

Ordering Information:
 HDGC3967HF-XP - ***
 1 2

- 1.Part No.
 2.Material:
 (blank):Nylon 66,UL94V-0
 GWT:Nylon 66,UL94V-0,GWT 750°C

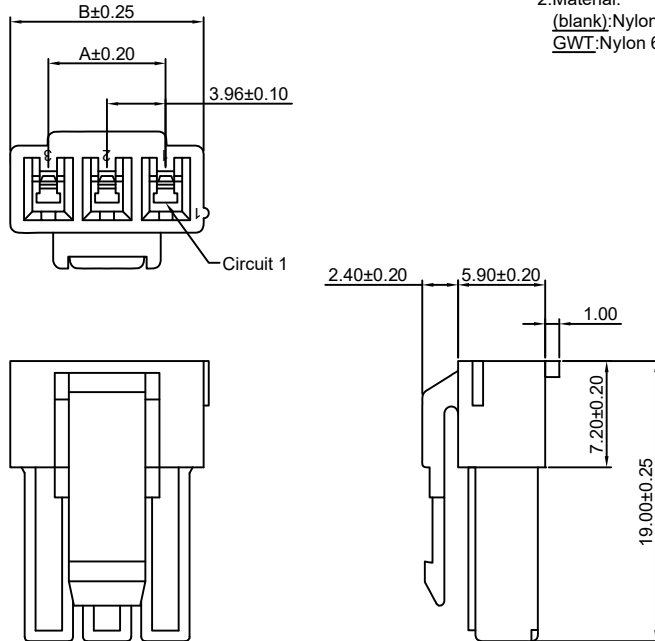

Ordering Information & Dimensions:

PART NO.	Dimensions	
	A	B
1P	----	5.20
2P	3.96	9.16
3P	7.92	13.12
4P	11.88	17.08
5P	15.84	21.04

Unit: mm

HDGC3967HM-XP

3.96mm Pitch Housing

Reference Informations:

- *Material:Nylon 66,UL94V-0
- *Suitable HDGC3967M-T series Terminal
- *Mates with HDGC3967HF-XP series Housing
- *Color: White

Ordering Information:
 HDGC3967HM-XP - ***
 1 2

- 1.Part No.
 2.Material:
 (blank):Nylon 66,UL94V-0
 GWT:Nylon 66,UL94V-0,GWT 750°C

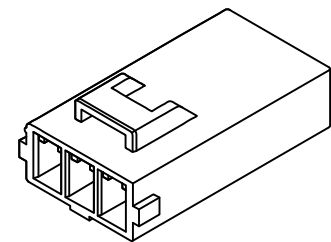
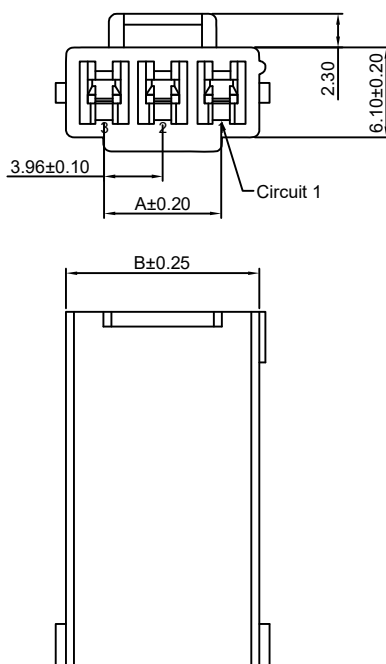

Ordering Information & Dimensions:

PART NO.	Dimensions	
	A	B
1P	----	5.20
2P	3.96	9.16
3P	7.92	13.12
4P	11.88	17.08
5P	15.84	21.04

Unit: mm



HDGC3967 Series 3.96mm (.156") Pitch Wire to Wire Connector

HDGC3967HF-2x3P

3.96mm Pitch Dual Row Housing

Reference Informations:

- *Material:Nylon 66,UL94V-0
- *Suitable HDGC3967F-T series Terminal
- *Mates with HDGC3967HM-2x3P series Housing
- *Color:White

Ordering Information:

- HDGC3967HF-2x3P - ***
- | | |
|---|---|
| 1 | 2 |
|---|---|
- Part No.
 - Material:
(blank):Nylon 66,UL94V-0
GWT:Nylon 66,UL94V-0,GWT 750°C

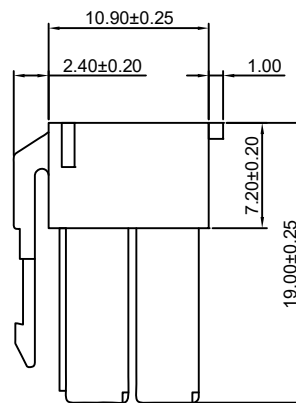
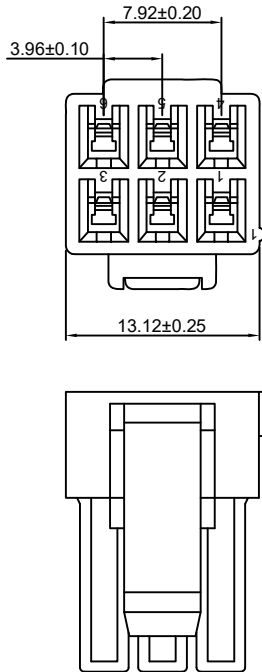

Unit: mm

HDGC3967HM-2x3P

3.96mm Pitch Dual Row Housing

Reference Informations:

- *Material:Nylon 66,UL94V-0
- *Suitable HDGC3967M-T series Terminal
- *Mates with HDGC3967HF-2x3P series Housing
- *Color:White

Ordering Information:

- HDGC3967HM-2x3P - ***
- | | |
|---|---|
| 1 | 2 |
|---|---|
- Part No.
 - Material:
(blank):Nylon 66,UL94V-0
GWT:Nylon 66,UL94V-0,GWT 750°C

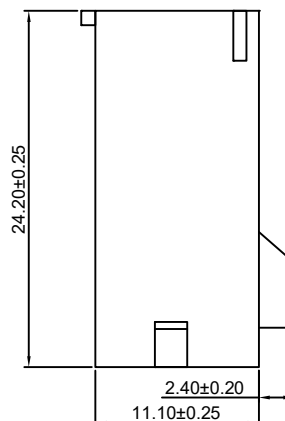
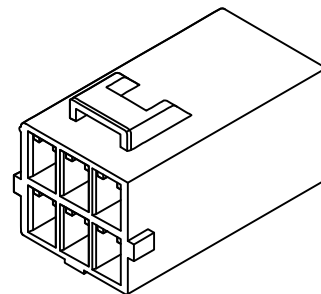
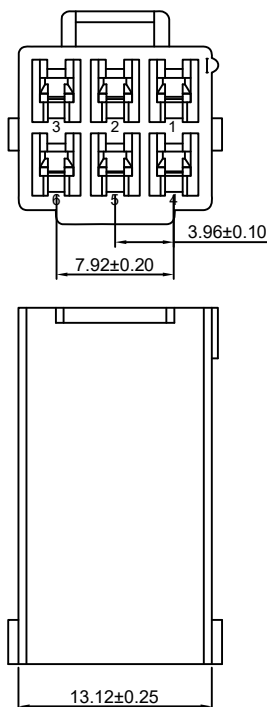

Unit: mm