

Specifications

- Current rating:3.2A AC,DC
- Voltage rating:350V AC,DC
- Temperature range:-25°C~+85°C
- Contact resistance:10mΩMax.
- Insulation resistance:1000MΩMin.
- Withstanding voltage:1700V AC/minute
- *Compliant with RoHS and REACH*
- *Meet the HF/Halogen Free,need to customize*
- *Contact HDGC for details*

Assembly layout

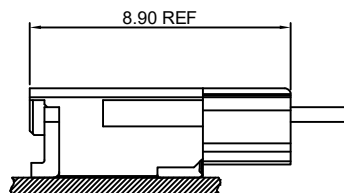



HDGC1801 Series 1.80mm (.071") Pitch Wire to Board Connector

HDGC1801-T

1.80mm pitch Crimp Terminal

Reference Informations:

* Used in HDGC801H, HA-2P series Housing

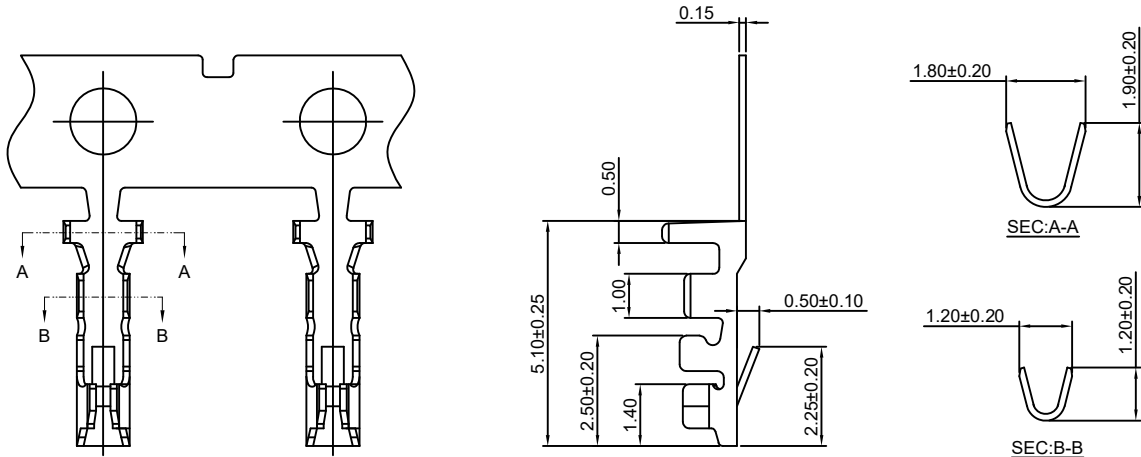

Ordering information & Specifications:

Unit:mm

Part NO.	Wire Range	Insulation O.D.	Material	Finish	Qty/reel
HDGC1801-TP	AWG#18-#24	2.70mm(max)	Phosphor Bronze	Tin over Nickel	10,000 PCS

HDGC1801H-2P

1.80mm pitch Housing

Reference Informations:

*Material:Nylon 66,UL94V-0

*Suitable HDGC1801-T series Terminal

*Mates with HDGC1801WR-S-XP series Wafer

*Color:White

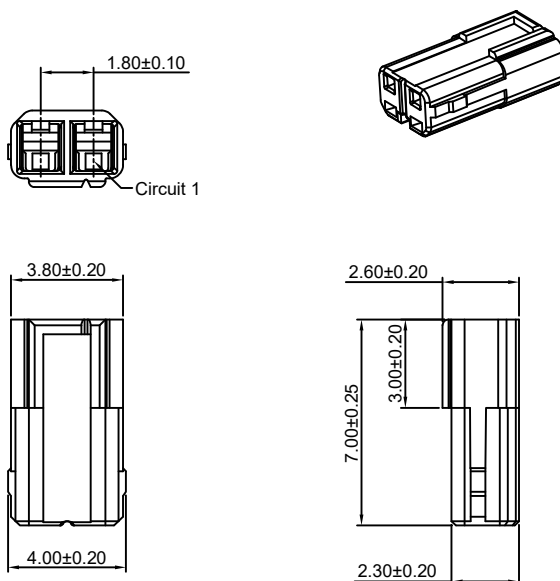

Ordering Information:

HDGC1801H-2P - -

1 2 3

- 1.Part No.
- 2.Material:
(blank):Nylon 66,UL94V-0
GWT:Nylon 66,UL94V-0,GWT 750 °C
- 3.Color:
(blank):White
RD:Red
YL:Yellow

Unit: mm



HDGC1801 SERIES



HDGC1801 Series 1.80mm (.071") Pitch Wire to Board Connector

HDGC1801HA-2P

1.80mm pitch Housing

Reference Informations:

- *Material:Nylon 66,UL94V-0
- *Suitable HDGC1801-T series Terminal
- *Mates with HDGC1801WRA-S-XP series Wafer
- *Color:White

Ordering Information:

HDGC1801HA-2P - ***
1 2

- 1.Part No.
- 2.Material:
(blank):Nylon 66,UL94V-0
GWT:Nylon 66,UL94V-0 GWT 750 °C

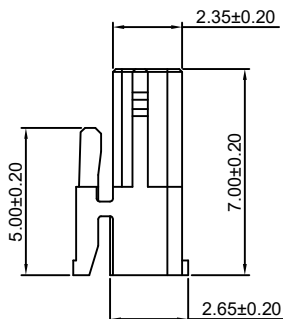
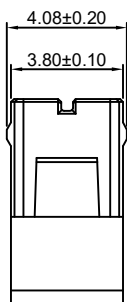
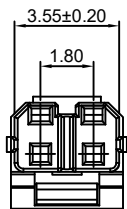

Unit: mm

HDGC1801WR-S-2P

1.80mm pitch 90° Wafer -SMT TYPE

Reference Informations:

- *Material:Pin:Brass/Tin over Nickel
Insulator:LCP,UL94V-0
- *Mates with HDGC1801H-2P series Housing
- *Color:White

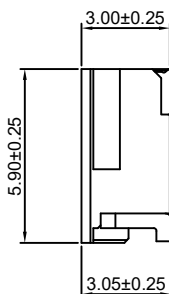
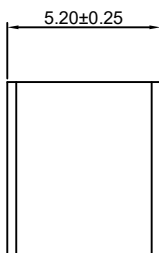
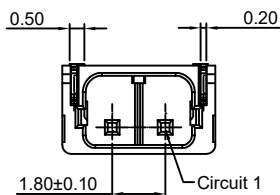
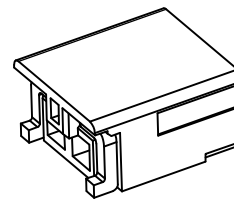
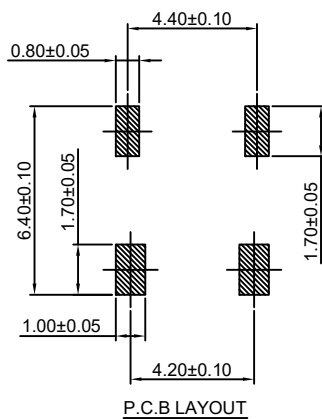

Ordering Information:

HDGC1801WR-S-2P - *** - **
1 2 3

- 1.Part No.
- 2.Material:
(blank):LCP,UL94V-0
GWT:LCP,UL94V-0,GWT 750 °C
- 3.Color:
(blank):White
RD:Red
YL:Yellow

Unit: mm



HDGC1801 Series 1.80mm (.071") Pitch Wire to Board Connector

HDGCGC1801WRA-S-2P

1.80mm pitch 90° Wafer -SMT TYPE

Reference Informations:

*Material:Pin:Brass/Tin over Nickel
Insulator:LCP,UL94V-0

*Mates with HDGC1801HA-2P series Housing

*Color:Ivory

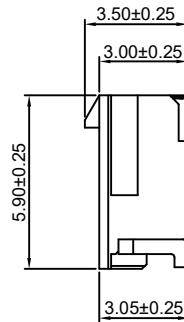
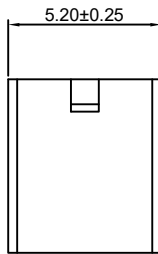
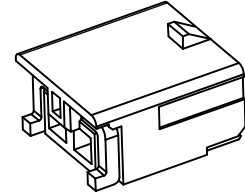
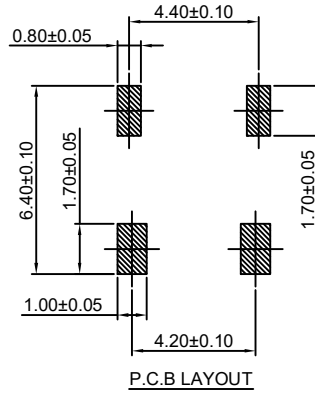
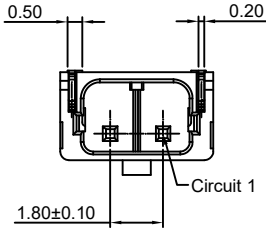

Ordering Information:

HDGC1801WRA-S-2P - ***
1 2

1.Part No.

2.Material:

(blank):LCP,UL94V-0

GWT:LCP,UL94V-0,GWT 750°C

Unit: mm