

## Specifications

- Current rating: 1.5A AC, DC
- Voltage rating: 30V AC, DC
- Temperature range: -25°C ~ +85°C
- Contact resistance: 20mΩ Max.
- Insulation resistance: 1000MΩ Min.
- Withstanding voltage: 500V AC/minute
- \*Compliant with RoHS and REACH\*
- \*Meet the HF/Halogen Free, need to customize\*
- \*Contact HDGC for details\*

## Assembly layout

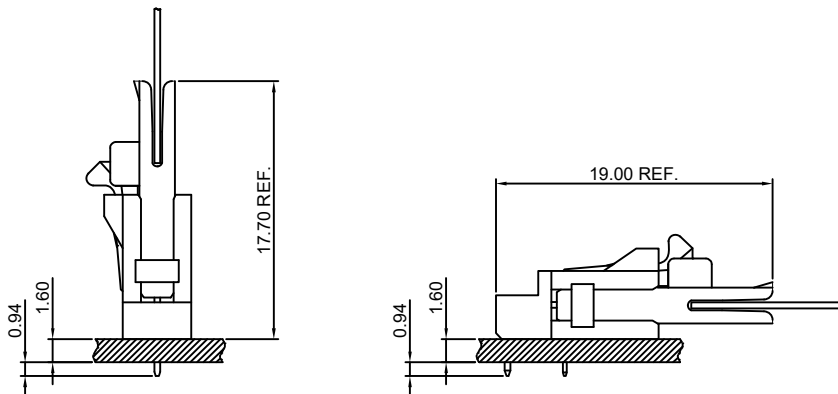



## HDGC1275 Series 1.27mm (.050") Pitch Wire to Board Connector

### HDGC1275-T

1.27mm pitch Crimp Terminal

**Reference Informations:**

\*Used in HDGC1275H,HA,HB,HC-XP,HDGC1275H,HA-2xXP series Housing

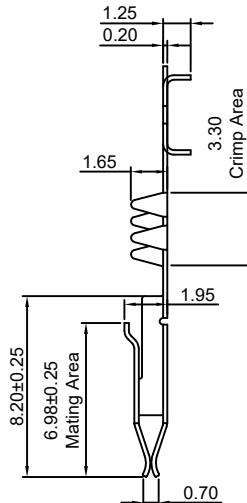
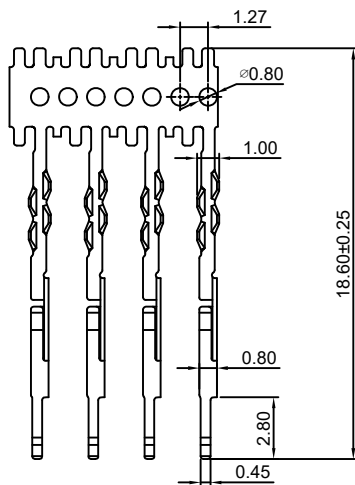

**Ordering Information:**

HDGC1275-GP - \*\*\*  
1 2

1.Part No.

2.Finish

- TG :Mating Area : 100µin (2.54µm) MIN. Tin  
Crimp Area: 1µin (0.025µm) MIN. Gold
- GT :Mating Area : 1µin (0.025µm) MIN. Gold  
Crimp Area: 100µin (2.54µm) MIN. Tin
- GT15 :Mating Area : 15µin (0.38µm) MIN. Gold  
Crimp Area: 100µin (2.54µm) MIN. Tin
- GT30 :Mating Area : 30µin (0.76µm) MIN. Gold  
Crimp Area: 100µin (2.54µm) MIN. Tin
- GT50 :Mating Area : 50µin (1.27µm) MIN. Gold  
Crimp Area: 100µin (2.54µm) MIN. Tin
- GG15 :Mating Area : 15µin (0.38µm) MIN. Gold  
Crimp Area: 1µin (0.025µm) MIN. Gold
- GG30 :Mating Area : 30µin (0.76µm) MIN. Gold  
Crimp Area: 1µin (0.025µm) MIN. Gold
- GG50 :Mating Area : 50µin (1.27µm) MIN. Gold  
Crimp Area: 1µin (0.025µm) MIN. Gold

**Ordering Information & Dimensions:**

Unit: mm

Part NO.	Wire Range	Insulation O.D.	Material	Finish	Qty/reel
HDGC1275-TP	FFC	----	Phosphor Bronze	Tin over Nickel	20,000 PCS
HDGC1275-GP	FFC	----	Phosphor Bronze	Gold over Nickel	20,000 PCS

Optional Gold plating available but MOQ requested

### HDGC1275M-T

1.27mm pitch Crimp Terminal

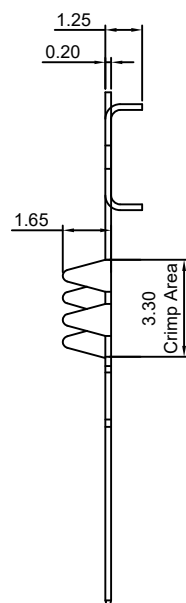
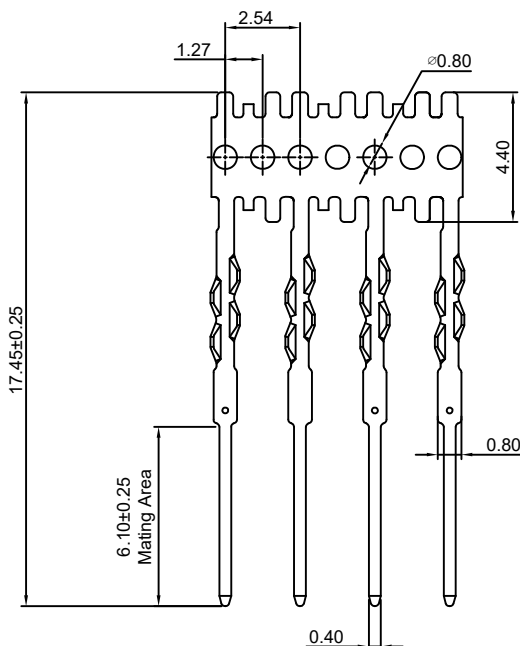

**Ordering Information:**

HDGC1275M-GP - \*\*\*  
1 2

1.Part No.

2.Finish

- TG :Mating Area : 100µin (2.54µm) MIN. Tin  
Crimp Area: 1µin (0.025µm) MIN. Gold
- GT15 :Mating Area : 15µin (0.38µm) MIN. Gold  
Crimp Area: 100µin (2.54µm) MIN. Tin
- GT30 :Mating Area : 30µin (0.76µm) MIN. Gold  
Crimp Area: 100µin (2.54µm) MIN. Tin
- GT50 :Mating Area : 50µin (1.27µm) MIN. Gold  
Crimp Area: 100µin (2.54µm) MIN. Tin
- GG15 :Mating Area : 15µin (0.38µm) MIN. Gold  
Crimp Area: 1µin (0.025µm) MIN. Gold
- GG30 :Mating Area : 30µin (0.76µm) MIN. Gold  
Crimp Area: 1µin (0.025µm) MIN. Gold
- GG50 :Mating Area : 50µin (1.27µm) MIN. Gold  
Crimp Area: 1µin (0.025µm) MIN. Gold

**Ordering Information & Dimensions:**

Unit: mm

Part NO.	Wire Range	Insulation O.D.	Material	Finish	Qty/reel
HDGC1275M-TP	FFC	----	Phosphor Bronze	Tin over Nickel	15,000 PCS
HDGC1275M-GP	FFC	----	Phosphor Bronze	Gold over Nickel	15,000 PCS

Optional Gold plating available but MOQ requested



## HDGC1275 Series 1.27mm (.050") Pitch Wire to Board Connector

### HDGC1275ML-T

1.27mm pitch Crimp Terminal

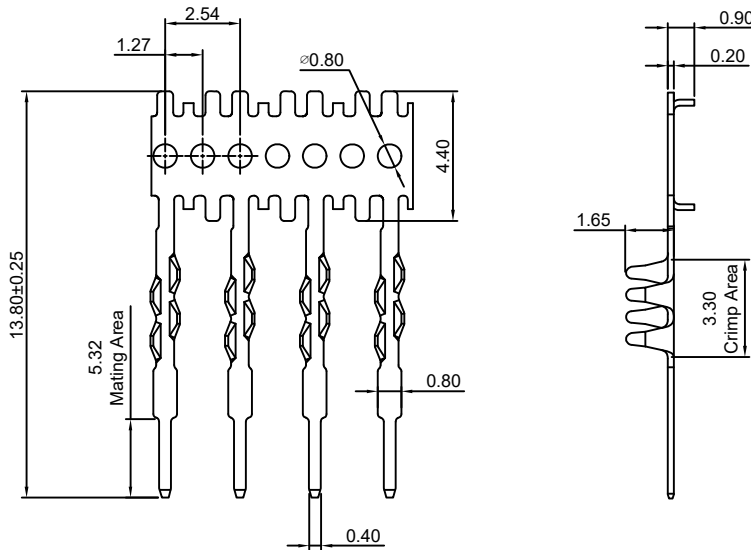

Ordering Information:  
**HDGC1275ML-GP - \*\*\***  
 1      2

- 1.Part No.
- 2.Finish
- TG** :Mating Area : 100µin (2.54µm) MIN. Tin  
 Crimp Area: 1µin (0.025µm) MIN. Gold
- GT15** :Mating Area : 15µin (0.38µm) MIN. Gold  
 Crimp Area: 100µin (2.54µm) MIN. Tin
- GT30** :Mating Area : 30µin (0.76µm) MIN. Gold  
 Crimp Area: 100µin (2.54µm) MIN. Tin
- GT50** :Mating Area : 50µin (1.27µm) MIN. Gold  
 Crimp Area: 100µin (2.54µm) MIN. Tin
- GG15** :Mating Area : 15µin (0.38µm) MIN. Gold  
 Crimp Area: 1µin (0.025µm) MIN. Gold
- GG30** :Mating Area : 30µin (0.76µm) MIN. Gold  
 Crimp Area: 1µin (0.025µm) MIN. Gold
- GG50** :Mating Area : 50µin (1.27µm) MIN. Gold  
 Crimp Area: 1µin (0.025µm) MIN. Gold

Ordering Information & Dimensions:

Unit: mm

Part NO.	Wire Range	Insulation O.D.	Material	Finish	Qty/reel
HDGC1275ML-TP	FFC	----	Phosphor Bronze	Tin over Nickel	15,000 PCS
HDGC1275ML-GP	FFC	----	Phosphor Bronze	Gold over Nickel	15,000 PCS

Optional Gold plating available but MOQ requested

### HDGC1275N-T

1.27mm pitch Crimp Terminal

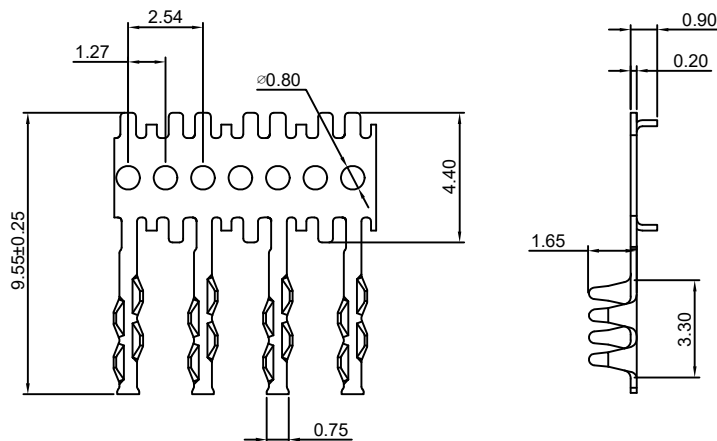

Ordering Information & Dimensions:

Unit: mm

Part NO.	Wire Range	Insulation O.D.	Material	Finish	Qty/reel
HDGC1275N-TP	FFC	----	Phosphor Bronze	Tin over Nickel	15,000 PCS
HDGC1275N-GP	FFC	----	Phosphor Bronze	Gold over Nickel	15,000 PCS

Optional Gold plating available but MOQ requested



## HDGC1275 Series 1.27mm (.050") Pitch Wire to Board Connector

### HDGC1275H-XP

1.27mm pitch Housing

**Reference Informations:**

- \*Material: Polyester, UL94V-0
- \*Suitable HDGC1275-T series Terminal
- \*Suitable HDGC1275WV, WR, WVA-XP series Wafer or HDGC1276WV, WR-XP series Single Row Wafer
- \*Color: Black

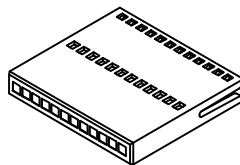
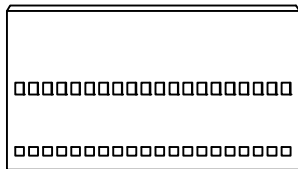
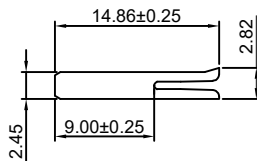
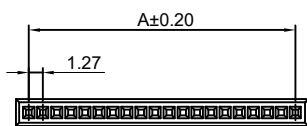
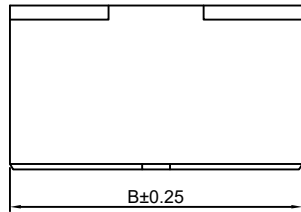

**Ordering Information & Dimensions:**

PART NO.	Dimensions		PART NO.	Dimensions	
	A	B		A	B
2P	1.27	3.63	27P	33.02	35.38
3P	2.54	4.90	28P	34.29	36.65
4P	3.81	6.17	29P	35.56	37.92
5P	5.08	7.44	30P	36.83	39.19
6P	6.35	8.71	31P	38.10	40.46
7P	7.62	9.98	32P	39.37	41.73
8P	8.89	11.25	33P	40.64	43.00
9P	10.16	12.52	34P	41.91	44.27
10P	11.43	13.79	35P	43.18	45.54
11P	12.70	15.06	36P	44.45	46.81
12P	13.97	16.33	37P	45.72	48.08
13P	15.24	17.60	38P	46.99	49.35
14P	16.51	18.87	39P	48.26	50.62
15P	17.78	20.14	40P	49.53	51.89
16P	19.05	21.41	41P	50.80	53.16
17P	20.32	22.68	42P	52.07	54.43
18P	21.59	23.95	43P	53.34	55.70
19P	22.86	25.22	44P	54.61	56.97
20P	24.13	26.49	45P	55.88	58.24
21P	25.40	27.76	46P	57.15	59.51
22P	26.67	29.03	47P	58.42	60.78
23P	27.94	30.30	48P	59.69	62.05
24P	29.21	31.57	49P	60.96	63.32
25P	30.48	32.84	50P	62.23	64.59
26P	31.75	34.11			

Unit: mm

### HDGC1275HA-XP

1.27mm pitch Housing

**Reference Informations:**

- \*Material: Polyester, UL94V-0
- \*Suitable HDGC1275-T series Terminal
- \*Suitable HDGC1275WV, WR, WVA-XP series Wafer
- \*Color: Black

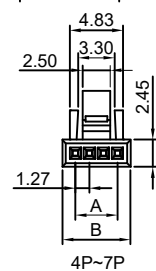
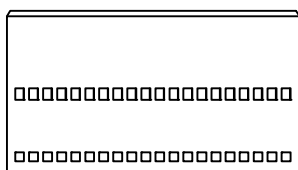
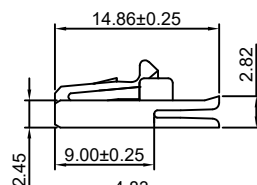
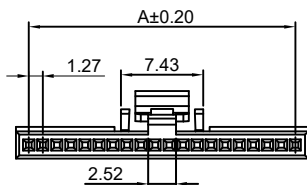
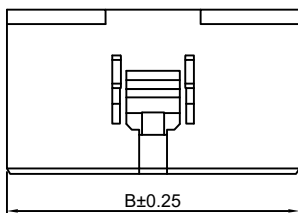

**Ordering Information & Dimensions:**

PART NO.	Dimensions		PART NO.	Dimensions	
	A	B		A	B
4P	3.81	6.17	28P	34.29	36.65
5P	5.08	7.44	29P	35.56	37.92
6P	6.35	8.71	30P	36.83	39.19
7P	7.62	9.98	31P	38.10	40.46
8P	8.89	11.25	32P	39.37	41.73
9P	10.16	12.52	33P	40.64	43.00
10P	11.43	13.79	34P	41.91	44.27
11P	12.70	15.06	35P	43.18	45.54
12P	13.97	16.33	36P	44.45	46.81
13P	15.24	17.60	37P	45.72	48.08
14P	16.51	18.87	38P	46.99	49.35
15P	17.78	20.14	39P	48.26	50.62
16P	19.05	21.41	40P	49.53	51.89
17P	20.32	22.68	41P	50.80	53.16
18P	21.59	23.95	42P	52.07	54.43
19P	22.86	25.22	43P	53.34	55.70
20P	24.13	26.49	44P	54.61	56.97
21P	25.40	27.76	45P	55.88	58.24
22P	26.67	29.03	46P	57.15	59.51
23P	27.94	30.30	47P	58.42	60.78
24P	29.21	31.57	48P	59.69	62.05
25P	30.48	32.84	49P	60.96	63.32
26P	31.75	34.11	50P	62.23	64.59
27P	33.02	35.38			

Unit: mm



## HDGC1275 Series 1.27mm (.050") Pitch Wire to Board Connector

### HDGC1275HB-XP

1.27mm pitch Housing

**Reference Informations:**

- \*Material: Polyester, UL94V-0
- \*Suitable HDGC1275-T series Terminal
- \*Suitable HDGC1275WV, WR, WVA-XP series Wafer or HDGC1276WV, WR-XP series Single Row Wafer
- \*Color: Black

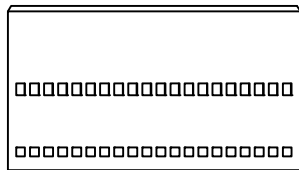
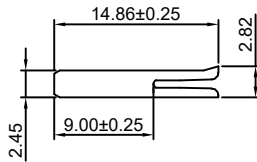
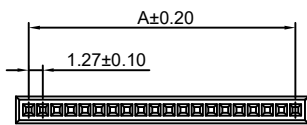

**Ordering Information & Dimensions:**

PART NO.	Dimensions		PART NO.	Dimensions	
	A	B		A	B
2P	1.27	3.63	27P	33.02	35.38
3P	2.54	4.90	28P	34.29	36.65
4P	3.81	6.17	29P	35.56	37.92
5P	5.08	7.44	30P	36.83	39.19
6P	6.35	8.71	31P	38.10	40.46
7P	7.62	9.98	32P	39.37	41.73
8P	8.89	11.25	33P	40.64	43.00
9P	10.16	12.52	34P	41.91	44.27
10P	11.43	13.79	35P	43.18	45.54
11P	12.70	15.06	36P	44.45	46.81
12P	13.97	16.33	37P	45.72	48.08
13P	15.24	17.60	38P	46.99	49.35
14P	16.51	18.87	39P	48.26	50.62
15P	17.78	20.14	40P	49.53	51.89
16P	19.05	21.41	41P	50.80	53.16
17P	20.32	22.68	42P	52.07	54.43
18P	21.59	23.95	43P	53.34	55.70
19P	22.86	25.22	44P	54.61	56.97
20P	24.13	26.49	45P	55.88	58.24
21P	25.40	27.76	46P	57.15	59.51
22P	26.67	29.03	47P	58.42	60.78
23P	27.94	30.30	48P	59.69	62.05
24P	29.21	31.57	49P	60.96	63.32
25P	30.48	32.84	50P	62.23	64.59
26P	31.75	34.11			

Unit: mm

### HDGC1275HC-XP

1.27mm pitch Housing

**Reference Informations:**

- \*Material: Polyester, UL94V-0
- \*Suitable HDGC1275-T series Terminal
- \*Suitable HDGC1275WV, WR, WVA-XP series Wafer
- \*Color: Black

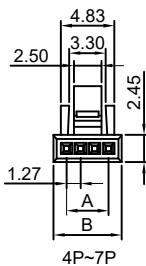
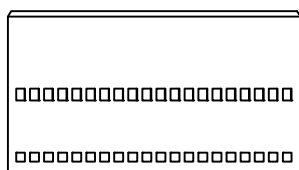
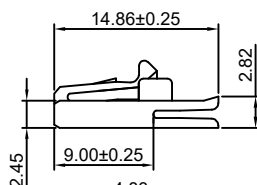
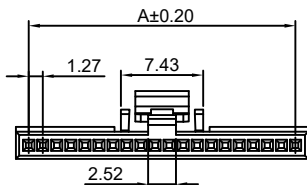
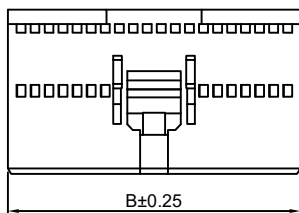

**Ordering Information & Dimensions:**

PART NO.	Dimensions		PART NO.	Dimensions	
	A	B		A	B
4P	3.81	6.17	28P	34.29	36.65
5P	5.08	7.44	29P	35.56	37.92
6P	6.35	8.71	30P	36.83	39.19
7P	7.62	9.98	31P	38.10	40.46
8P	8.89	11.25	32P	39.37	41.73
9P	10.16	12.52	33P	40.64	43.00
10P	11.43	13.79	34P	41.91	44.27
11P	12.70	15.06	35P	43.18	45.54
12P	13.97	16.33	36P	44.45	46.81
13P	15.24	17.60	37P	45.72	48.08
14P	16.51	18.87	38P	46.99	49.35
15P	17.78	20.14	39P	48.26	50.62
16P	19.05	21.41	40P	49.53	51.89
17P	20.32	22.68	41P	50.80	53.16
18P	21.59	23.95	42P	52.07	54.43
19P	22.86	25.22	43P	53.34	55.70
20P	24.13	26.49	44P	54.61	56.97
21P	25.40	27.76	45P	55.88	58.24
22P	26.67	29.03	46P	57.15	59.51
23P	27.94	30.30	47P	58.42	60.78
24P	29.21	31.57	48P	59.69	62.05
25P	30.48	32.84	49P	60.96	63.32
26P	31.75	34.11	50P	62.23	64.59
27P	33.02	35.38			

Unit: mm



## HDGC1275 Series 1.27mm (.050") Pitch Wire to Board Connector

### HDGC1275H-2xXP

1.27mm pitch Dual Row Housing

#### Reference Informations:

- \*Material: Polyester, UL94V-0
- \*Suitable HDGC1275-T series Terminal
- \*Suitable HDGC1275WV-2xXP, WR-2xXP series Wafer or HDGC1276WVB, WRB-2xXP series Dual Row Wafer
- \*Color: Black

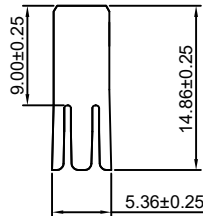
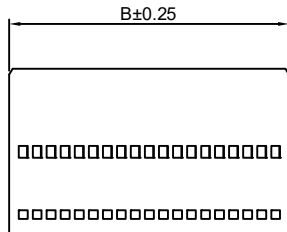
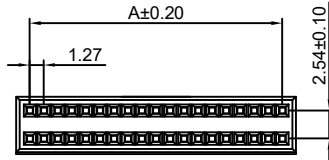
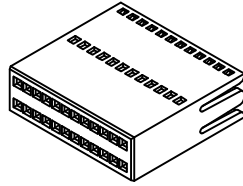

#### Ordering Information & Dimensions:

PART NO.	Dimensions		PART NO.	Dimensions	
	A	B		A	B
2x5P	5.08	7.54	2x28P	34.29	36.75
2x6P	6.35	8.81	2x29P	35.56	38.02
2x7P	7.62	10.08	2x30P	36.83	39.29
2x8P	8.89	11.35	2x31P	38.10	40.56
2x9P	10.16	12.62	2x32P	39.37	41.83
2x10P	11.43	13.89	2x33P	40.64	43.10
2x11P	12.70	15.16	2x34P	41.91	44.37
2x12P	13.97	16.43	2x35P	43.18	45.64
2x13P	15.24	17.70	2x36P	44.45	46.91
2x14P	16.51	18.97	2x37P	45.72	48.18
2x15P	17.78	20.24	2x38P	46.99	49.45
2x16P	19.05	21.51	2x39P	48.26	50.72
2x17P	20.32	22.78	2x40P	49.53	51.99
2x18P	21.59	24.05	2x41P	50.80	53.26
2x19P	22.86	25.32	2x42P	52.07	54.53
2x20P	24.13	26.59	2x43P	53.34	55.80
2x21P	25.40	27.86	2x44P	54.61	57.07
2x22P	26.67	29.13	2x45P	55.88	58.34
2x23P	27.94	30.40	2x46P	57.15	59.61
2x24P	29.21	31.67	2x47P	58.42	60.88
2x25P	30.48	32.94	2x48P	59.69	62.15
2x26P	31.75	34.21	2x49P	60.96	63.42
2x27P	33.02	35.48	2x50P	62.23	64.69

Unit: mm

### HDGC1275HA-2xXP

1.27mm pitch Dual Row Housing

#### Reference Informations:

- \*Material: Polyester, UL94V-0
- \*Suitable HDGC1275-T series Terminal
- \*Suitable HDGC1275WV-2xXP, WR-2xXP series Wafer
- \*Color: Black

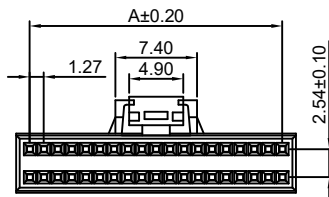

2x6P~2x50P

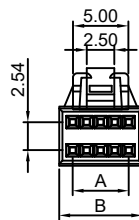

2x5P

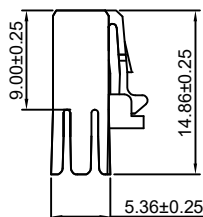
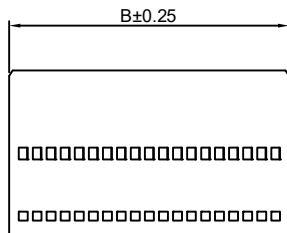

#### Ordering Information & Dimensions:

PART NO.	Dimensions		PART NO.	Dimensions	
	A	B		A	B
2x5P	5.08	7.54	2x28P	34.29	36.75
2x6P	6.35	8.81	2x29P	35.56	38.02
2x7P	7.62	10.08	2x30P	36.83	39.29
2x8P	8.89	11.35	2x31P	38.10	40.56
2x9P	10.16	12.62	2x32P	39.37	41.83
2x10P	11.43	13.89	2x33P	40.64	43.10
2x11P	12.70	15.16	2x34P	41.91	44.37
2x12P	13.97	16.43	2x35P	43.18	45.64
2x13P	15.24	17.70	2x36P	44.45	46.91
2x14P	16.51	18.97	2x37P	45.72	48.18
2x15P	17.78	20.24	2x38P	46.99	49.45
2x16P	19.05	21.51	2x39P	48.26	50.72
2x17P	20.32	22.78	2x40P	49.53	51.99
2x18P	21.59	24.05	2x41P	50.80	53.26
2x19P	22.86	25.32	2x42P	52.07	54.53
2x20P	24.13	26.59	2x43P	53.34	55.80
2x21P	25.40	27.86	2x44P	54.61	57.07
2x22P	26.67	29.13	2x45P	55.88	58.34
2x23P	27.94	30.40	2x46P	57.15	59.61
2x24P	29.21	31.67	2x47P	58.42	60.88
2x25P	30.48	32.94	2x48P	59.69	62.15
2x26P	31.75	34.21	2x49P	60.96	63.42
2x27P	33.02	35.48	2x50P	62.23	64.69

Unit: mm



## HDGC1275 Series 1.27mm (.050") Pitch Wire to Board Connector

### HDGC1275WV-XP

1.27mm pitch 180° Wafer

**Reference Informations:**

- \*Material: Pin: Phosphor Bronze/Tin over Nickel  
Insulator: Nylon 9T+15%GF, UL94V-0
- \*Suitable HDGC1275H, HA, HB, HC-XP series Housing
- \*Color: Black

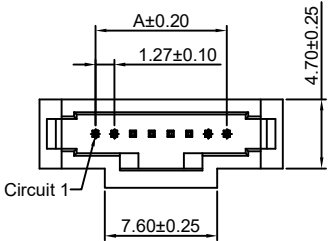
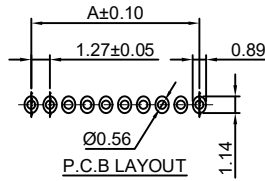

Ordering Information:  
**HDGC1275WV-XP - \*\*\* - \*\*\***  
 1 2 3

1. Part No.  
 2. Material:  
 (Blank): Nylon 9T, UL94V-0  
 GWT: Nylon 9T, UL94V-0, GWT 750 °C  
 3. Finish:  
 (Blank): Tin over Nickel  
 G: Gold-flash  
 G15: 15µm (0.38µm) MIN. Select Gold (Mating Area)  
 100µm (2.54µm) MIN. Select Tin  
 G30: 30µm (0.76µm) MIN. Select Gold (Mating Area)  
 100µm (2.54µm) MIN. Select Tin  
 G50: 50µm (1.27µm) MIN. Select Gold (Mating Area)  
 100µm (2.54µm) MIN. Select Tin

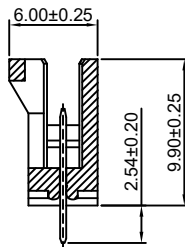
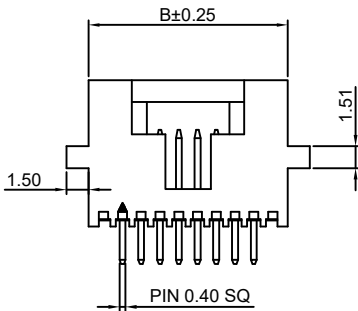

**Ordering Information & Dimensions:**

PART NO.	Dimensions		PART NO.	Dimensions	
	A	B		A	B
4P	3.81	8.41	28P	34.29	38.89
5P	5.08	9.68	29P	35.56	40.16
6P	6.35	10.95	30P	36.83	41.43
7P	7.62	12.22	31P	38.10	42.70
8P	8.89	13.49	32P	39.37	43.97
9P	10.16	14.76	33P	40.64	45.24
10P	11.43	16.03	34P	41.91	46.51
11P	12.70	17.30	35P	43.18	47.78
12P	13.97	18.57	36P	44.45	49.05
13P	15.24	19.84	37P	45.72	50.32
14P	16.51	21.11	38P	46.99	51.59
15P	17.78	22.38	39P	48.26	52.86
16P	19.05	23.65	40P	49.53	54.13
17P	20.32	24.92	41P	50.80	55.40
18P	21.59	26.19	42P	52.07	56.67
19P	22.86	27.46	43P	53.34	57.94
20P	24.13	28.73	44P	54.61	59.21
21P	25.40	30.00	45P	55.88	60.48
22P	26.67	31.27	46P	57.15	61.75
23P	27.94	32.54	47P	58.42	63.02
24P	29.21	33.81	48P	59.69	64.29
25P	30.48	35.08	49P	60.96	65.56
26P	31.75	36.35	50P	62.23	66.83
27P	33.02	37.62			

Unit: mm

### HDGC1275WR-XP

1.27mm pitch 90° Wafer

**Reference Informations:**

- \*Material: Pin: Phosphor Bronze/Tin over Nickel  
Insulator: Nylon 9T+15%GF, UL94V-0
- \*Suitable HDGC1275H, HA, HB, HC-XP series Housing
- \*Color: Black

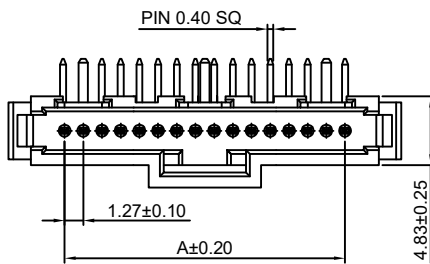
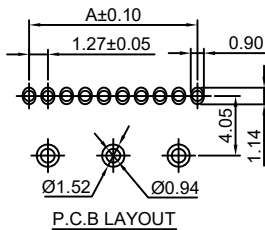

Ordering Information:  
**HDGC1275WR-XP - \*\*\* - \*\*\***  
 1 2 3

1. Part No.  
 2. Material:  
 (Blank): Nylon 9T, UL94V-0  
 GWT: Nylon 9T, UL94V-0, GWT 750 °C  
 3. Finish:  
 (Blank): Tin over Nickel  
 G: Gold-flash  
 G15: 15µm (0.38µm) MIN. Select Gold (Mating Area)  
 100µm (2.54µm) MIN. Select Tin  
 G30: 30µm (0.76µm) MIN. Select Gold (Mating Area)  
 100µm (2.54µm) MIN. Select Tin  
 G50: 50µm (1.27µm) MIN. Select Gold (Mating Area)  
 100µm (2.54µm) MIN. Select Tin

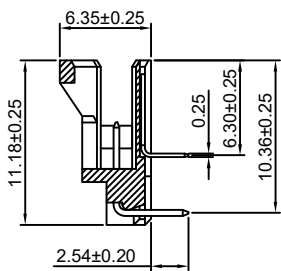
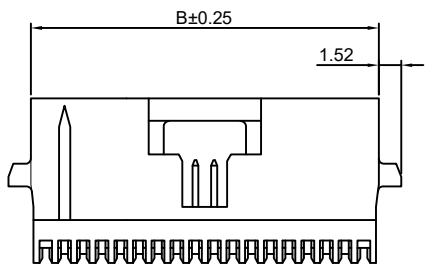

**Ordering Information & Dimensions:**

PART NO.	Dimensions		PART NO.	Dimensions	
	A	B		A	B
4P	3.81	8.41	28P	34.29	38.89
5P	5.08	9.68	29P	35.56	40.16
6P	6.35	10.95	30P	36.83	41.43
7P	7.62	12.22	31P	38.10	42.70
8P	8.89	13.49	32P	39.37	43.97
9P	10.16	14.76	33P	40.64	45.24
10P	11.43	16.03	34P	41.91	46.51
11P	12.70	17.30	35P	43.18	47.78
12P	13.97	18.57	36P	44.45	49.05
13P	15.24	19.84	37P	45.72	50.32
14P	16.51	21.11	38P	46.99	51.59
15P	17.78	22.38	39P	48.26	52.86
16P	19.05	23.65	40P	49.53	54.13
17P	20.32	24.92	41P	50.80	55.40
18P	21.59	26.19	42P	52.07	56.67
19P	22.86	27.46	43P	53.34	57.94
20P	24.13	28.73	44P	54.61	59.21
21P	25.40	30.00	45P	55.88	60.48
22P	26.67	31.27	46P	57.15	61.75
23P	27.94	32.54	47P	58.42	63.02
24P	29.21	33.81	48P	59.69	64.29
25P	30.48	35.08	49P	60.96	65.56
26P	31.75	36.35	50P	62.23	66.83
27P	33.02	37.62			

Unit: mm



## HDGC1275 Series 1.27mm (.050") Pitch Wire to Board Connector

### HDGC1275WVA-XP — 1.27mm pitch 180° Wafer

**Reference Informations:**

- \*Material: Pin: Phosphor Bronze/Tin over Nickel  
Insulator: Nylon 9T+15%GF, UL94V-0
- \*Suitable HDGC1275H, HA, HB, HC-XP series Housing
- \*Color: Black

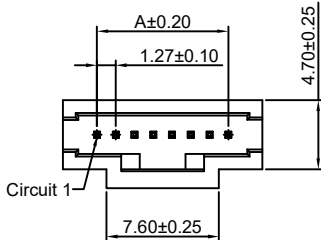
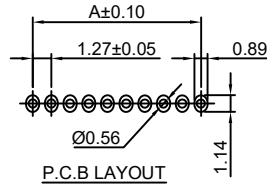

Ordering Information:  
**HDGC1275WVA-XP - \*\*\* - \*\*\***  
 1 2 3

1. Part No.  
 2. Material:  
 (Blank): Nylon 9T, UL94V-0  
 GWT : Nylon 9T, UL94V-0 GWT 750 °C  
 3. Finish:  
 (Blank): Tin over Nickel  
 G: Gold-flash  
 G15: 15µm (0.38µm) MIN. Select Gold (Mating Area)  
 100µm (2.54µm) MIN. Select Tin  
 G30: 30µm (0.76µm) MIN. Select Gold (Mating Area)  
 100µm (2.54µm) MIN. Select Tin  
 G50: 50µm (1.27µm) MIN. Select Gold (Mating Area)  
 100µm (2.54µm) MIN. Select Tin

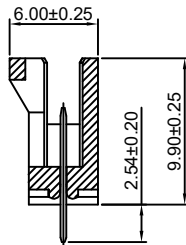
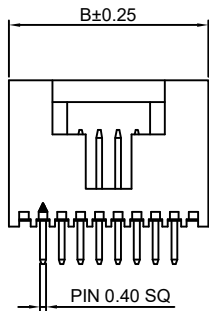

**Ordering Information & Dimensions:**

PART NO.	Dimensions		PART NO.	Dimensions	
	A	B		A	B
4P	3.81	8.41	28P	34.29	38.89
5P	5.08	9.68	29P	35.56	40.16
6P	6.35	10.95	30P	36.83	41.43
7P	7.62	12.22	31P	38.10	42.70
8P	8.89	13.49	32P	39.37	43.97
9P	10.16	14.76	33P	40.64	45.24
10P	11.43	16.03	34P	41.91	46.51
11P	12.70	17.30	35P	43.18	47.78
12P	13.97	18.57	36P	44.45	49.05
13P	15.24	19.84	37P	45.72	50.32
14P	16.51	21.11	38P	46.99	51.59
15P	17.78	22.38	39P	48.26	52.86
16P	19.05	23.65	40P	49.53	54.13
17P	20.32	24.92	41P	50.80	55.40
18P	21.59	26.19	42P	52.07	56.67
19P	22.86	27.46	43P	53.34	57.94
20P	24.13	28.73	44P	54.61	59.21
21P	25.40	30.00	45P	55.88	60.48
22P	26.67	31.27	46P	57.15	61.75
23P	27.94	32.54	47P	58.42	63.02
24P	29.21	33.81	48P	59.69	64.29
25P	30.48	35.08	49P	60.96	65.56
26P	31.75	36.35	50P	62.23	66.83
27P	33.02	37.62			

Unit: mm

### HDGC1275WV-2xXP — 1.27mm pitch 180° Wafer

**Reference Informations:**

- \*Material: Pin: Phosphor Bronze/Gold over Nickel  
Insulator: Nylon 9T+15%GF, UL94V-0
- \*Suitable HDGC1275H, HA-2xXP series Housing
- \*Color: Black

Ordering Information:  
**HDGC1275WV-2xXP - \*\*\* - \*\*\***  
 1 2 3

1. Part No.  
 2. Material:  
 (Blank): Nylon 9T, UL94V-0  
 GWT : Nylon 9T, UL94V-0 GWT 750 °C  
 3. Finish:  
 (Blank): Gold-flash  
 G15: 15µm (0.38µm) MIN. Select Gold (Mating Area)  
 100µm (2.54µm) MIN. Select Tin  
 G30: 30µm (0.76µm) MIN. Select Gold (Mating Area)  
 100µm (2.54µm) MIN. Select Tin  
 G50: 50µm (1.27µm) MIN. Select Gold (Mating Area)  
 100µm (2.54µm) MIN. Select Tin  
 T: Tin over Nickel

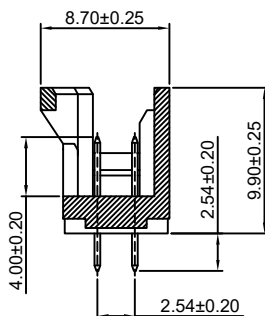
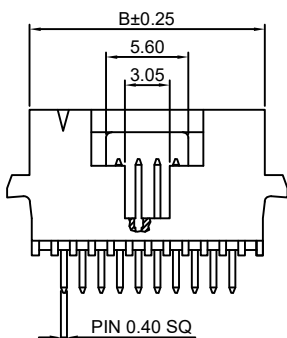
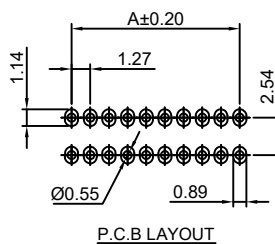
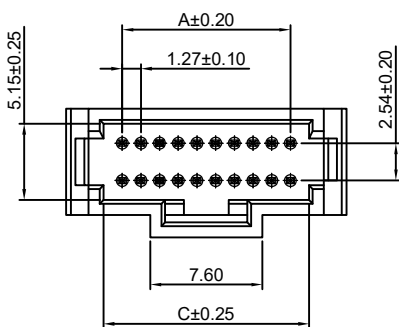
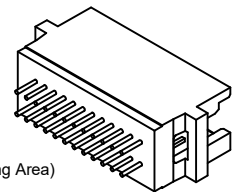

**Ordering Information & Dimensions:**

PART NO.	Dimensions			PART NO.	Dimensions		
	A	B	C		A	B	C
2x5P	5.08	9.65	7.65	2x21P	25.40	29.97	27.97
2x6P	6.35	10.92	8.92	2x22P	26.67	31.24	29.24
2x7P	7.62	12.19	10.19	2x23P	27.94	32.51	30.51
2x8P	8.89	13.46	11.46	2x24P	29.21	33.78	31.78
2x9P	10.16	14.73	12.73	2x25P	30.48	35.05	33.05
2x10P	11.43	16.00	14.00	2x26P	31.75	36.32	34.32
2x11P	12.70	17.27	15.27	2x27P	33.02	37.59	35.59
2x12P	13.97	18.54	16.54	2x28P	34.29	38.86	36.86
2x13P	15.24	19.81	17.81	2x29P	35.56	40.13	38.13
2x14P	16.51	21.08	19.08	2x30P	36.83	41.40	39.40
2x15P	17.78	22.35	20.35	2x31P	38.10	42.67	40.67
2x16P	19.05	23.62	21.62	2x32P	39.37	43.94	41.94
2x17P	20.32	24.89	22.89	2x33P	40.64	45.21	43.21
2x18P	21.59	26.16	24.16	2x34P	41.91	46.48	44.48
2x19P	22.86	27.43	25.43	2x35P	43.18	47.75	45.75
2x20P	24.13	28.70	26.70	2x36P	44.45	49.02	47.02

Unit: mm





## HDGC1275 Series 1.27mm (.050") Pitch Wire to Board Connector

### HDGC1275WR-2xXP

1.27mm pitch 90° Wafer

#### Reference Informations:

- \*Material: Pin: Phosphor Bronze/Gold over Nickel  
Insulator: Nylon 9T+15%GF, UL94V-0
- \*Suitable HDGC1275H, HA-2xXP series Housing
- \*Color: Black

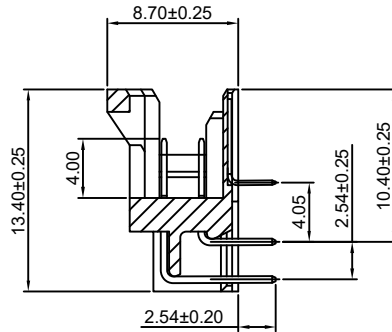
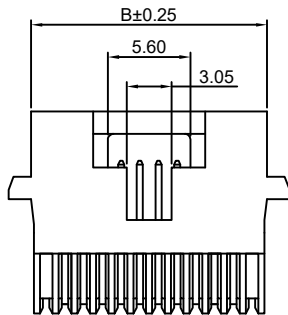
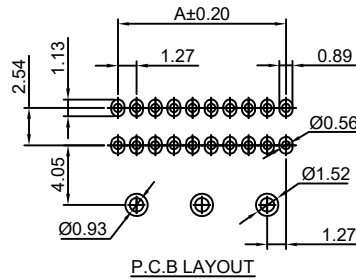
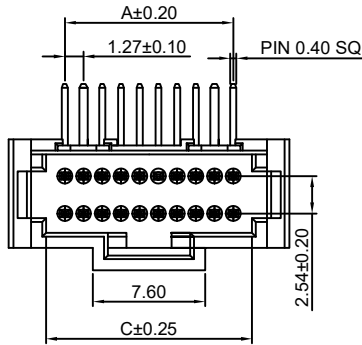

#### Ordering Information:

HDGC1275WR-2xXP - \*\*\* - \*\*\*  
1 2 3

- Part No.
- Material:  
(Blank): Nylon 9T, UL94V-0  
GWT : Nylon 9T, UL94V-0 GWT 750 °C
- Finish:  
(Blank): Gold-flash  
G15: 15µm (0.38µm) MIN. Select Gold (Mating Area)  
100µm (2.54µm) MIN. Select Tin  
G30: 30µm (0.76µm) MIN. Select Gold (Mating Area)  
100µm (2.54µm) MIN. Select Tin  
G50: 50µm (1.27µm) MIN. Select Gold (Mating Area)  
100µm (2.54µm) MIN. Select Tin  
T: Tin over Nickel

#### Ordering Information & Dimensions:

PART NO.	Dimensions			PART NO.	Dimensions		
	A	B	C		A	B	C
2x5P	5.08	9.65	7.65	2x21P	25.40	29.97	27.97
2x6P	6.35	10.92	8.92	2x22P	26.67	31.24	29.24
2x7P	7.62	12.19	10.19	2x23P	27.94	32.51	30.51
2x8P	8.89	13.46	11.46	2x24P	29.21	33.78	31.78
2x9P	10.16	14.73	12.73	2x25P	30.48	35.05	33.05
2x10P	11.43	16.00	14.00	2x26P	31.75	36.32	34.32
2x11P	12.70	17.27	15.27	2x27P	33.02	37.59	35.59
2x12P	13.97	18.54	16.54	2x28P	34.29	38.86	36.86
2x13P	15.24	19.81	17.81	2x29P	35.56	40.13	38.13
2x14P	16.51	21.08	19.08	2x30P	36.83	41.40	39.40
2x15P	17.78	22.35	20.35	2x31P	38.10	42.67	40.67
2x16P	19.05	23.62	21.62	2x32P	39.37	43.94	41.94
2x17P	20.32	24.89	22.89	2x33P	40.64	45.21	43.21
2x18P	21.59	26.16	24.16	2x34P	41.91	46.48	44.48
2x19P	22.86	27.43	25.43	2x35P	43.18	47.75	45.75
2x20P	24.13	28.70	26.70	2x36P	44.45	49.02	47.02

Unit: mm