

修订 REV	标记 MARK	修改摘要 REVISION DESCRIPTION	签名 SIGNATURE	日期 DATE
AO		NEW RELEASE	WANG	2015-05-16

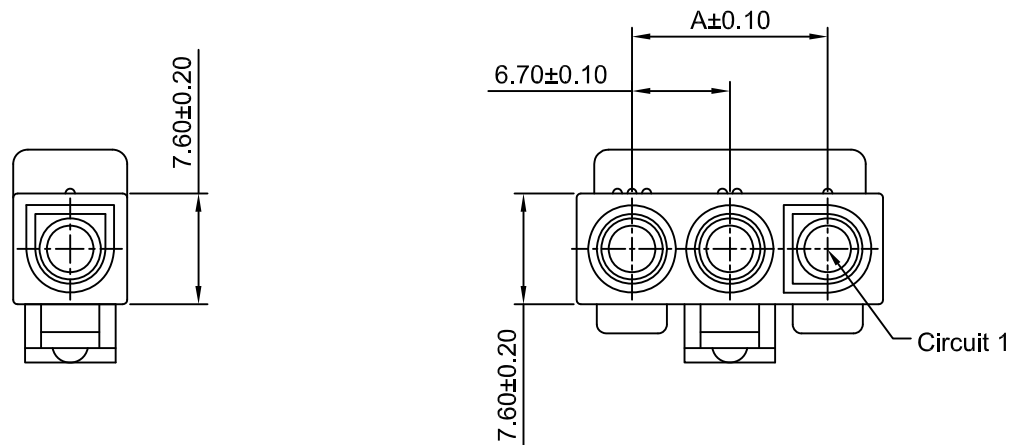

Ordering Information:

HDGC6701HF-XP - **

1 2

1.Part No.

2.Material:

(blank):UL94V-2/Natural

V0:UL94V-0/White

SPECIFICATIONS:

Current Rating: 12A AC,DC

Voltage Rating: 600V AC,DC

Temperature Range: -25°C ~ +85°C

Contact Resistance: 10mΩ Max

Insulation Resistance: 1000MΩ Min

Withstanding Voltage: 1500V AC/minute

Material: Nylon 66,UL94V-2(Natural)

Ordering Information & Dimensions

Circuits	Dimensions(mm)		Circuits	Dimensions(mm)	
	A	B		A	B
1P	----	7.80	3P	13.40	21.00
2P	6.70	14.30	4P	20.10	27.70

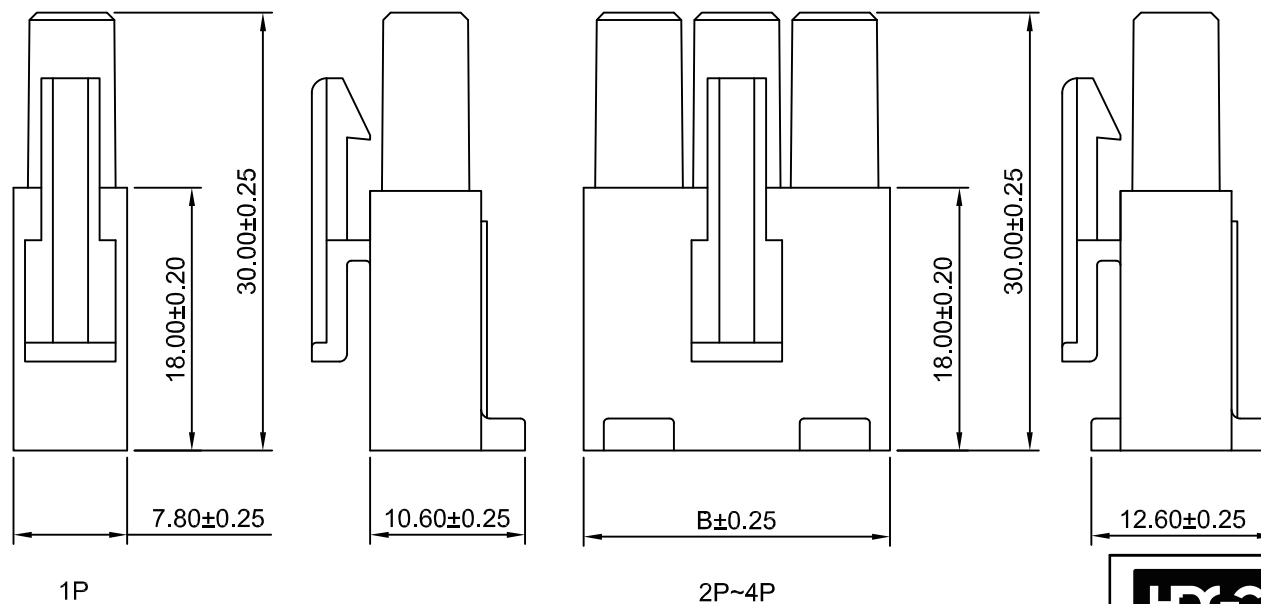

深圳市华德共创科技有限公司

SHENZHEN HUADE CO-CREATE TECHNOLOGY CO.,LTD

TEL : 0755-27129737 FAX : 0755-29940187

-TOLERANCES- UNLESS OTHERWISE SPECIFIED 公差参数表						TITLE: 6.70mm Pitch Housing 产品名称 :			
X.X	±0.30	X.X°	±3°	APPD: 核准:	XIE	PART NO: 产品编号 : HDGC6701HF-XP			
X.XX	±0.30	X.XX°	±2°	CHECK: 校对:	WANG	DATE	SCALE	UNIT	CODE NUMBER
X.XXX	±0.10	X.XXX°	±1°	DRAW: 绘图:	WANG	2015-05-16	2:1	mm	A008

修订 REV	标记 MARK	修改摘要 REVISION DESCRIPTION	签名 SIGNATURE	日期 DATE
AO		NEW RELEASE	WANG	2015-05-16

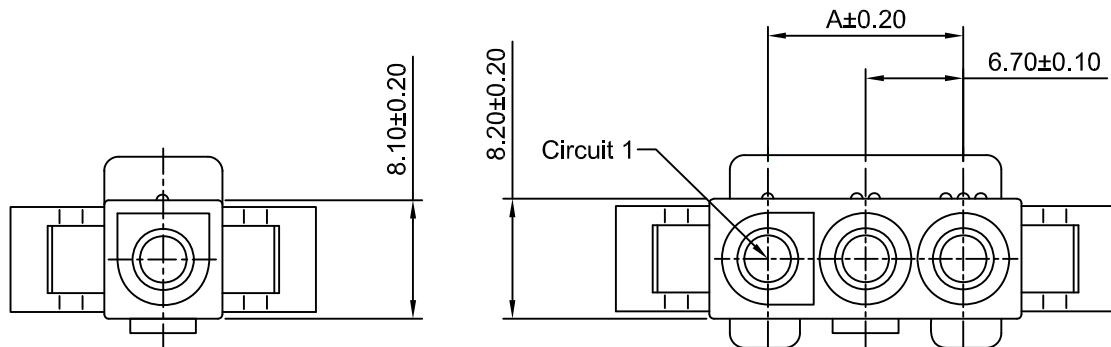

Ordering Information:

HDGC6701HM-XP - **
1 2

1.Part No.

2.Material:

(blank):UL94V-2/Natural

V0:UL94V-0/White

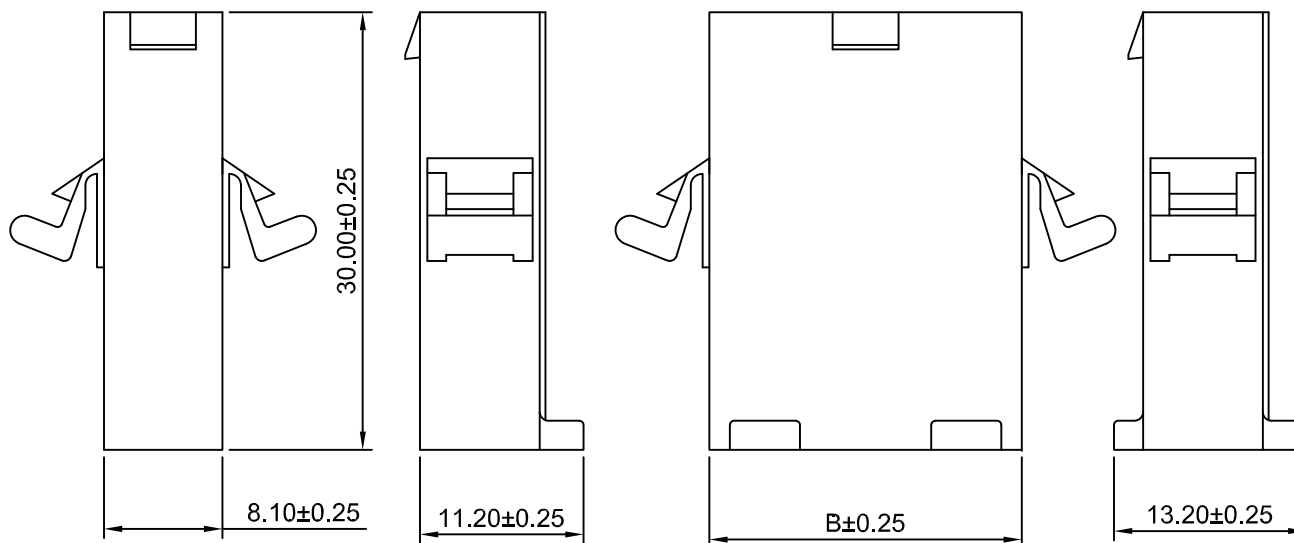

SPECIFICATIONS:

Current Rating: 12A AC,DC

Voltage Rating: 600V AC,DC

Temperature Range: -25°C ~ +85°C

Contact Resistance: 10mΩ Max

Insulation Resistance: 1000MΩ Min

Withstanding Voltage: 1500V AC/minute

Material: Nylon 66,UL94V-2(Natural)

Ordering Information & Dimensions

Circuits	Dimensions(mm)		Circuits	Dimensions(mm)	
	A	B		A	B
1P	----	8.10	3P	13.40	21.40
2P	6.70	14.70	4P	20.10	28.10



深圳市华德共创科技有限公司

SHENZHEN HUADE CO-CREATE TECHNOLOGY CO.,LTD

TEL : 0755-27129737 FAX : 0755-29940187

-TOLERANCES- UNLESS OTHERWISE SPECIFIED 公差参数表				TITLE: 产品名称: 6.70mm Pitch Housing	
X.X	±0.30	X.X°	±3°	APPD: 核准:	XIE
X.XX	±0.30	X.XX°	±2°	CHECK: 校对:	WANG
X.XXX	±0.10	X.XXX°	±1°	DRAW: 绘图:	WANG
PART NO: 产品编号:				HDGC6701HM-XP	
DATE		SCALE	UNIT	CODE NUMBER	
2015-05-16		2:1	mm	A008	

修订 REV	标记 MARK	修改摘要 REVISION DESCRIPTION	签名 SIGNATURE	日期 DATE
AO		NEW RELEASE	WANG	2015-05-16

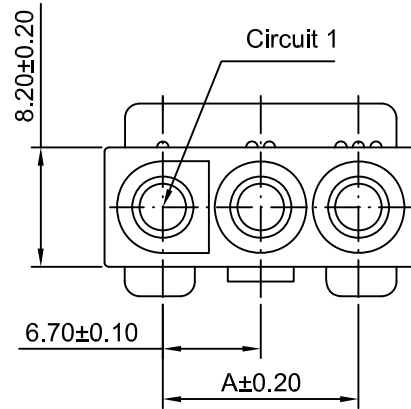
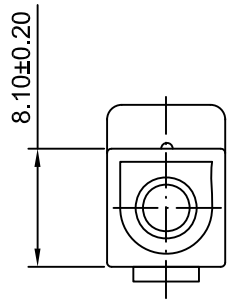

Ordering Information:
HDGC6701HMA-XP - **
1 2

1.Part No.
 2.Material:
(blank):UL94V-2/Natural
V0:UL94V-0/White

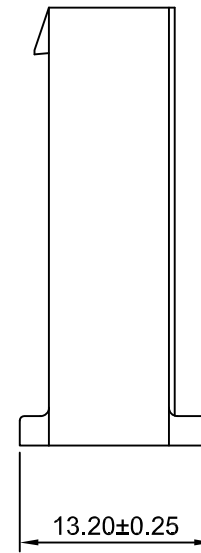
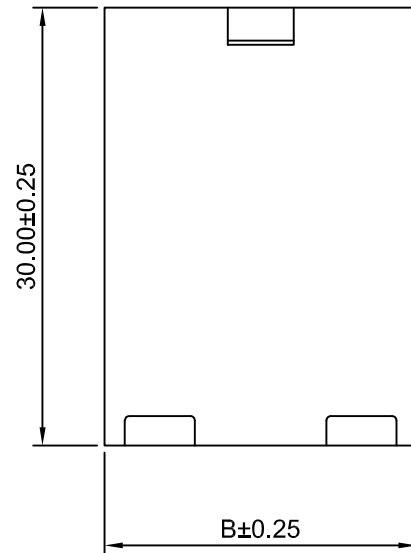
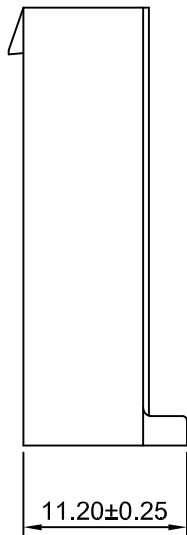
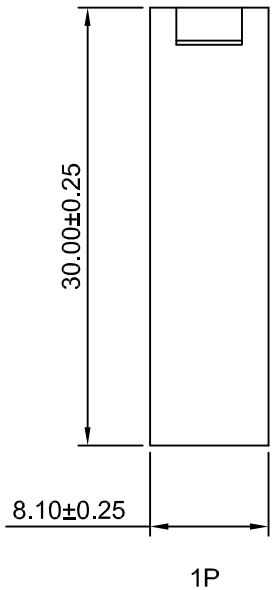

SPECIFICATIONS:

Current Rating: 12A AC,DC
 Voltage Rating: 600V AC,DC
 Temperature Range: -25°C ~ +85°C
 Contact Resistance: 10mΩ Max
 Insulation Resistance: 1000MΩ Min
 Withstanding Voltage: 1500V AC/minute
 Material: Nylon 66,UL94V-2(Natural)

Ordering Information & Dimensions

Circuits	Dimensions(mm)		Circuits	Dimensions(mm)	
	A	B		A	B
1P	----	8.10	3P	13.40	21.40
2P	6.70	14.70	4P	20.10	28.10



深圳市华德共创科技有限公司

SHENZHEN HUADE CO-CREATE TECHNOLOGY CO.,LTD

TEL : 0755-27129737 FAX : 0755-29940187

-TOLERANCES-
UNLESS OTHERWISE SPECIFIED
公差参数表

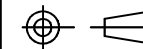

TITLE: 6.70mm Pitch
产品名称: Housing

X.X ±0.30 X.X° ±3°

APPD: 核准: XIE

PART NO: 产品编号: HDGC6701HMA-XP

X.XX ±0.30 X.XX° ±2°

CHECK: 校对: WANG

DATE SCALE UNIT CODE NUMBER

X.XXX ±0.10 X.XXX° ±1°

DRAW: 绘图: WANG

2015-05-16 2:1 mm A008

修订 REV	标记 MARK	修改摘要 REVISION DESCRIPTION	签名 SIGNATURE	日期 DATE
AO		NEW RELEASE	WANG	2015-05-16

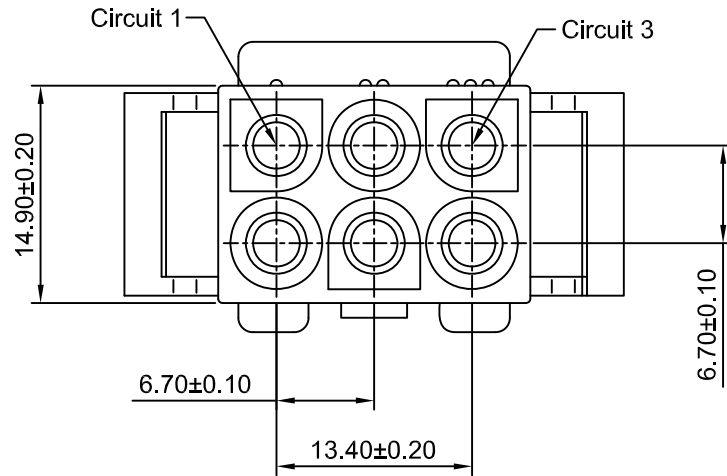

Ordering Information:

HDGC6701HM-2xXP - **
1 2

1.Part No.

2.Material:

(blank):UL94V-2/Natural

V0:UL94V-0/White

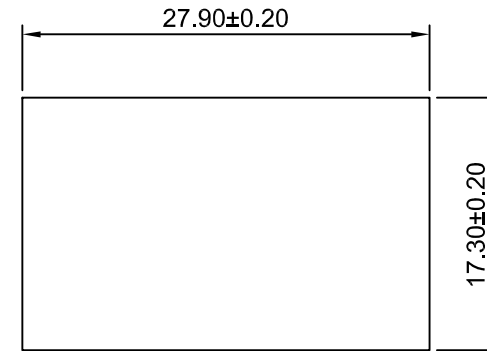

Panel Hole Layout

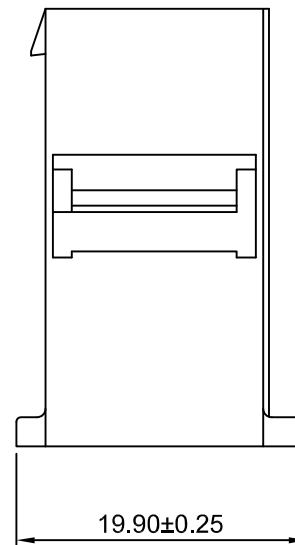
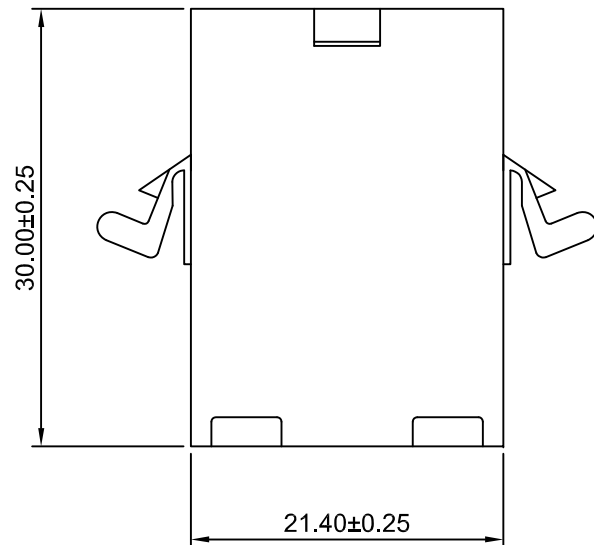

SPECIFICATIONS:

Current Rating: 12A AC,DC

Voltage Rating: 600V AC,DC

Temperature Range: -25°C ~ +85°C

Contact Resistance: 10mΩ Max

Insulation Resistance: 1000MΩ Min

Withstanding Voltage: 1500V AC/minute

Material: Nylon 66,UL94V-2(Natural)



深圳市华德共创科技有限公司

SHENZHEN HUADE CO-CREATE TECHNOLOGY CO.,LTD

TEL : 0755-27129737 FAX : 0755-29940187

-TOLERANCES- UNLESS OTHERWISE SPECIFIED 公差参数表						TITLE: 6.70mm Pitch Housing 产品名称:			
X.X	±0.30	X.X°	±3°	APPD: 核准:	XIE	PART NO: 产品编号: HDGC6701HM-2xXP			
X.XX	±0.30	X.XX°	±2°	CHECK: 校对:	WANG	DATE	SCALE	UNIT	CODE NUMBER
X.XXX	±0.10	X.XXX°	±1°	DRAW: 绘图:	WANG	2015-05-16	2:1	mm	A008

修订 REV	标记 MARK	修改摘要 REVISION DESCRIPTION	签名 SIGNATURE	日期 DATE
AO		NEW RELEASE	WANG	2015-05-16

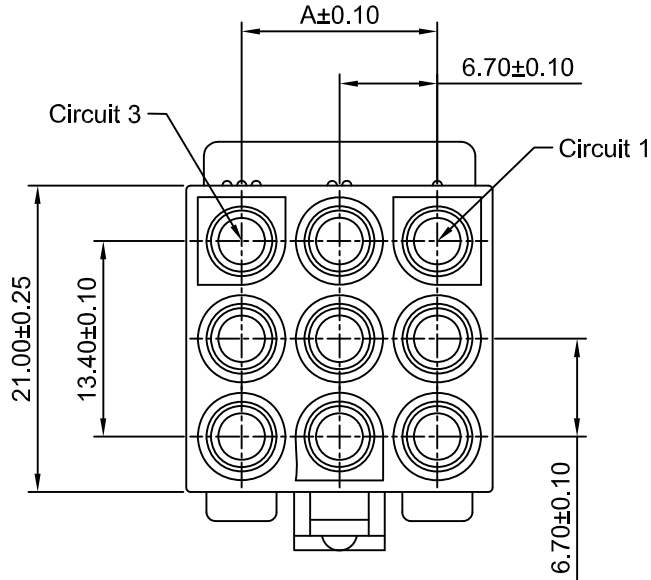

Ordering Information:

HDGC6701HF-3xXP - **
1 2

- 1.Part No.
- 2.Material:
(blank):UL94V-2/Natural
V0:UL94V-0/White

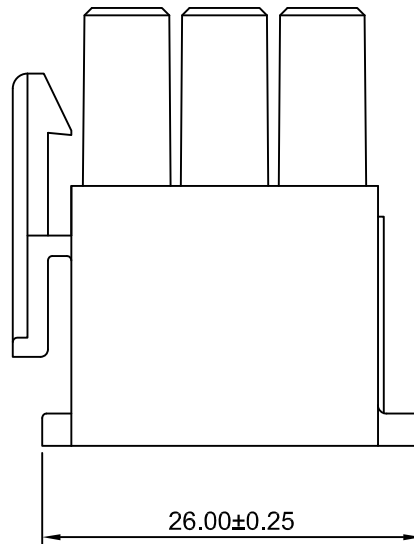
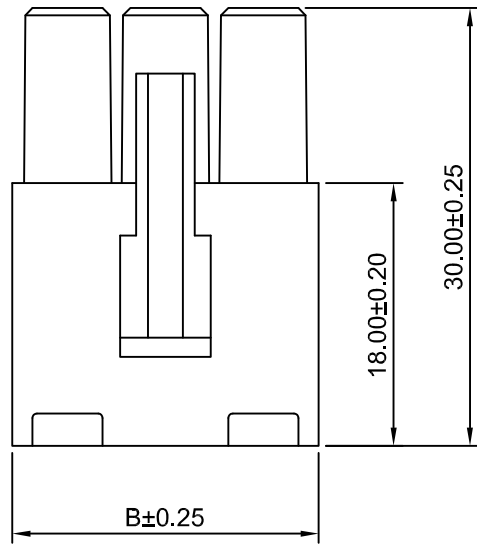

SPECIFICATIONS

- Current Rating: 12A AC,DC
- Voltage Rating: 600V AC,DC
- Temperature Range: -25°C ~ +85°C
- Contact Resistance: 10mΩ Max
- Insulation Resistance: 1000MΩ Min
- Withstanding Voltage: 1500V AC/minute
- Material: Nylon 66,UL94V-2(Natural)

Ordering Information & Dimensions

Circuits	Dimensions(mm)		Circuits	Dimensions(mm)	
	A	B		A	B
3x3P	13.40	21.00	3x5P	26.80	34.40
3x4P	20.10	27.70			



深圳市华德共创科技有限公司

SHENZHEN HUADE CO-CREATE TECHNOLOGY CO.,LTD

TEL : 0755-27129737 FAX : 0755-29940187

-TOLERANCES- UNLESS OTHERWISE SPECIFIED 公差参数表						TITLE: 6.70mm Pitch 产品名称: Housing			
X.X	±0.30	X.X°	±3°	APPD: 核准:	XIE	PART NO: 产品编号: HDGC6701HF-3xXP			
X.XX	±0.30	X.XX°	±2°	CHECK: 校对:	WANG	DATE	SCALE	UNIT	CODE NUMBER
X.XXX	±0.10	X.XXX°	±1°	DRAW: 绘图:	WANG	2015-05-16	2:1	mm	A008

修订 REV	标记 MARK	修改摘要 REVISION DESCRIPTION	签名 SIGNATURE	日期 DATE
AO		NEW RELEASE	WANG	2015-05-16

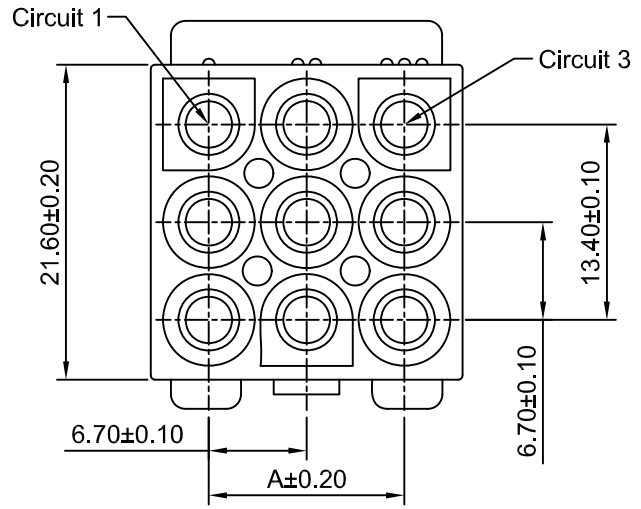

Ordering Information:
HDGC6701HMA-3xXP - **
 1 2

1.Part No.
2.Material:
(blank):UL94V-2/Natural
V0:UL94V-0/White

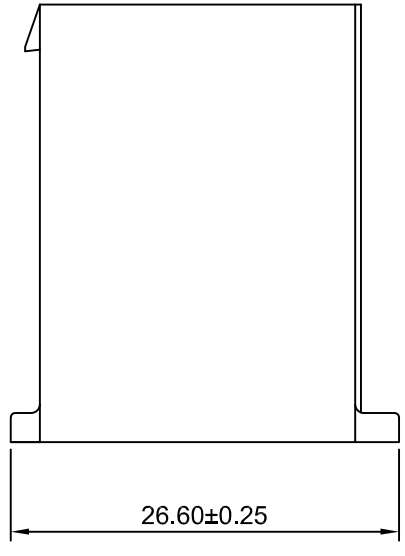
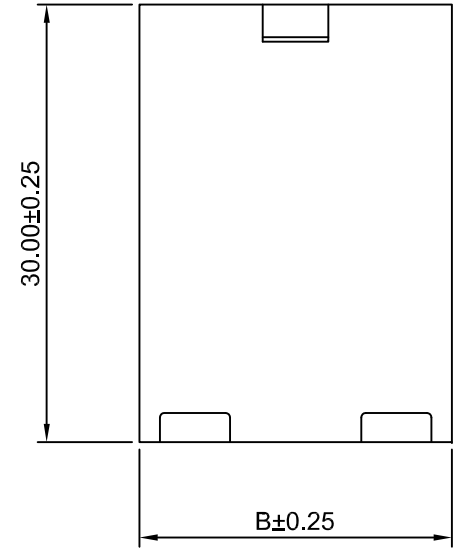

SPECIFICATIONS:
 Current Rating: 12A AC,DC
 Voltage Rating: 600V AC,DC
 Temperature Range: -25°C ~ +85°C
 Contact Resistance: 10mΩ Max
 Insulation Resistance: 1000MΩ Min
 Withstanding Voltage: 1500V AC/minute
 Material: Nylon 66,UL94V-2(Natural)



Ordering Information & Dimensions

Circuits	Dimensions(mm)		Circuits	Dimensions(mm)	
	A	B		A	B
3x3P	13.40	21.40	3x5P	26.80	34.80
3x4P	20.10	28.10			



深圳市华德共创科技有限公司

SHENZHEN HUADE CO-CREATE TECHNOLOGY CO.,LTD
 TEL : 0755-27129737 FAX : 0755-29940187

-TOLERANCES- UNLESS OTHERWISE SPECIFIED 公差参数表				 		TITLE: 6.70mm Pitch Housing 产品名称 :			
X.X	±0.30	X.X°	±3°	APPD: 核准 :	XIE	PART NO: 产品编号 : HDGC6701HMA-3xXP			
X.XX	±0.30	X.XX°	±2°	CHECK: 校对 :	WANG	DATE	SCALE	UNIT	CODE NUMBER
X.XXX	±0.10	X.XXX°	±1°	DRAW: 绘图 :	WANG	2015-05-16	2:1	mm	A008

修订 REV	标记 MARK	修改摘要 REVISION DESCRIPTION	签名 SIGNATURE	日期 DATE
AO		NEW RELEASE	WANG	2015-05-16

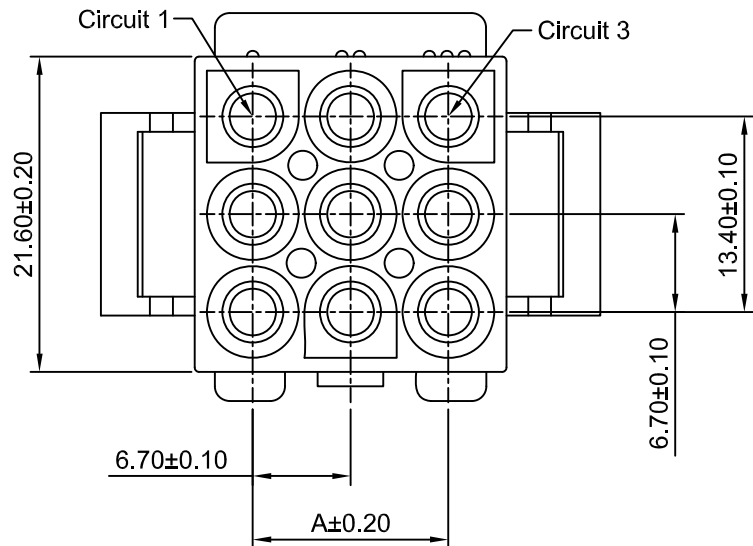

Ordering Information:
 HDGC6701HM-3xXP - **
 1 2

- 1.Part No.
- 2.Material:
 (blank):UL94V-2/Natural
 V0:UL94V-0/White

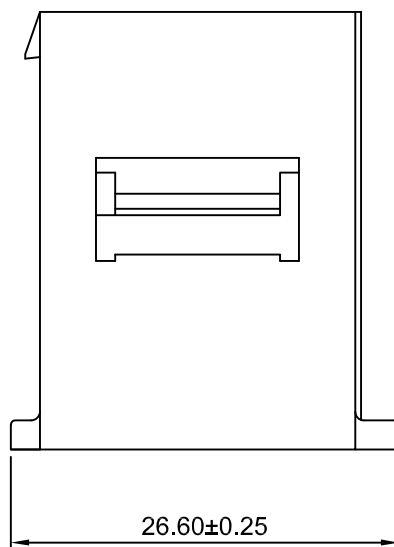
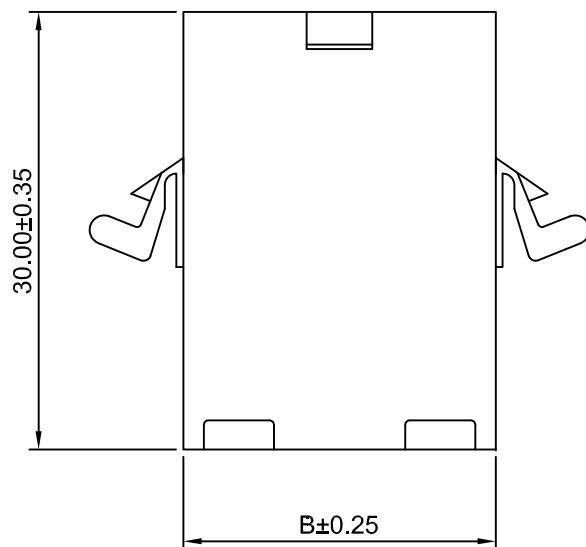

SPECIFICATIONS:

Current Rating: 12A AC,DC
 Voltage Rating: 600V AC,DC
 Temperature Range: -25°C ~ +85°C
 Contact Resistance: 10mΩ Max
 Insulation Resistance: 1000MΩ Min
 Withstanding Voltage: 1500V AC/minute
 Material: Nylon 66,UL94V-2(Natural)

Ordering Information & Dimensions

Circuits	Dimensions(mm)		Circuits	Dimensions(mm)	
	A	B		A	B
3x3P	13.40	21.40	3x5P	26.80	34.80
3x4P	20.10	28.10			



深圳市华德共创科技有限公司

SHENZHEN HUADE CO-CREATE TECHNOLOGY CO.,LTD

TEL : 0755-27129737 FAX : 0755-29940187

-TOLERANCES- UNLESS OTHERWISE SPECIFIED 公差参数表						TITLE: 6.70mm Pitch Housing 产品名称:			
X.X	±0.30	X.X°	±3°	APPD: 核准:	XIE	PART NO: 产品编号: HDGC6701HM-3xXP			
X.XX	±0.30	X.XX°	±2°	CHECK: 校对:	WANG	DATE	SCALE	UNIT	CODE NUMBER
X.XXX	±0.10	X.XXX°	±1°	DRAW: 绘图:	WANG	2015-05-16	2:1	mm	A008

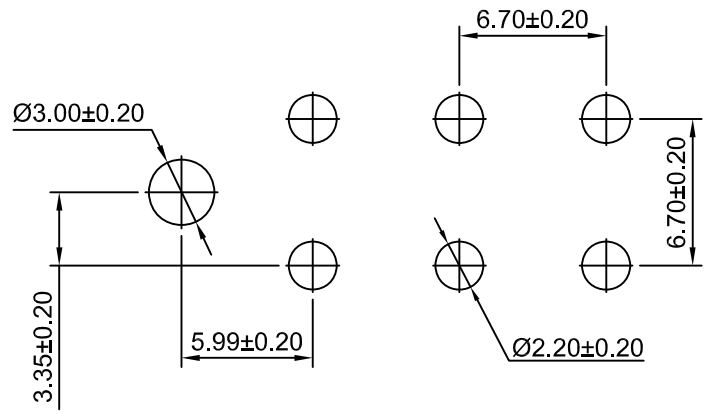
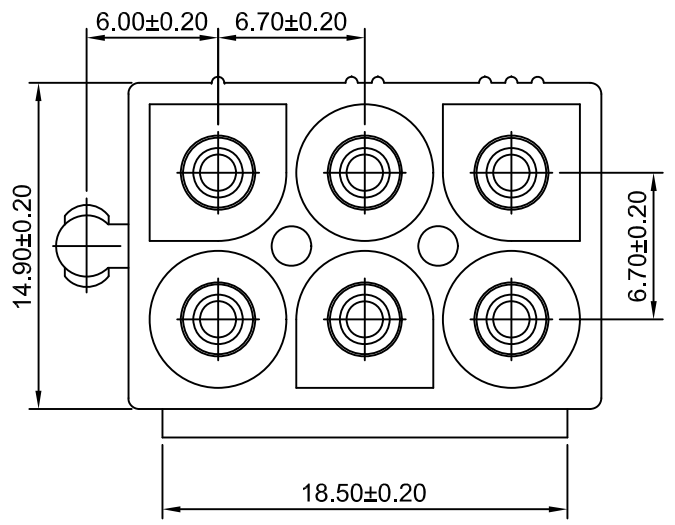

修订 REV	标记 MARK	修改摘要 REVISION DESCRIPTION	签名 SIGNATURE	日期 DATE
AO		NEW RELEASE	WANG	2015-05-16

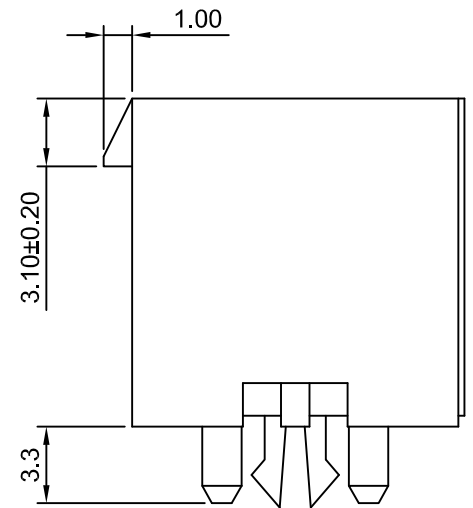
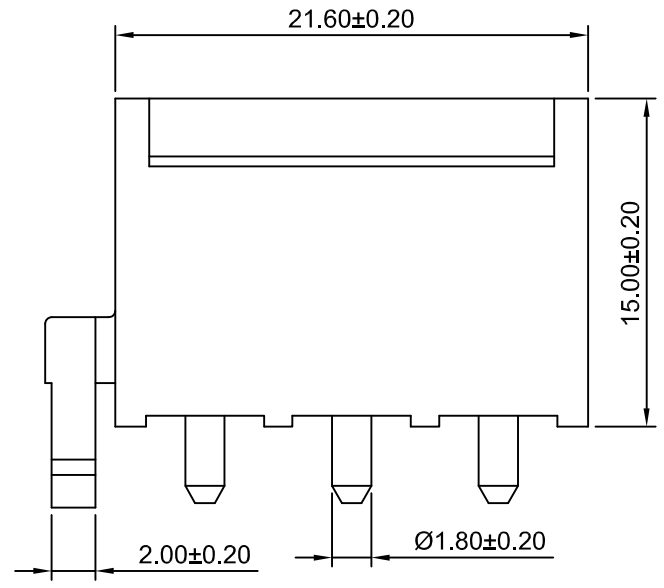

P.C.B LAYOUT



SPECIFICATIONS:
 Current Rating: 9A AC,DC
 Voltage Rating: 600V AC,DC
 Temperature Range: -25°C ~ +85°C
 Contact Resistance: 20mΩ Max.
 Insulation Resistance: 1000MΩ Min.
 Withstanding Voltage: 5000V AC/minute
 Pin Material: Brass/Tin Over Nickel
 Material: Nylon 66 UL94V-2(Natural)

 深圳市华德共创科技有限公司 SHENZHEN HUADE CO-CREATE TECHNOLOGY CO.,LTD TEL : 0755-27129737 FAX : 0755-29940187				TITLE: 6.70mm Pitch Housing 产品名称: Housing					
				PART NO: HDGC6701WV-2x3P 产品编号:					
-TOLERANCES- UNLESS OTHERWISE SPECIFIED 公差参数表				 		APPD: XIE 核准:		DATE: 2015-05-16 日期:	
X.X	±0.30	X.X°	±3°	CHECK: WANG 校对:		SCALE: 3:1	UNIT: mm	CODE NUMBER: A008	
X.XX	±0.30	X.XX°	±2°	DRAW: WANG 绘图:					
X.XXX	±0.10	X.XXX°	±1°						

修订 REV	标记 MARK	修改摘要 REVISION DESCRIPTION	签名 SIGNATURE	日期 DATE
AO		NEW RELEASE	WANG	2015-05-16

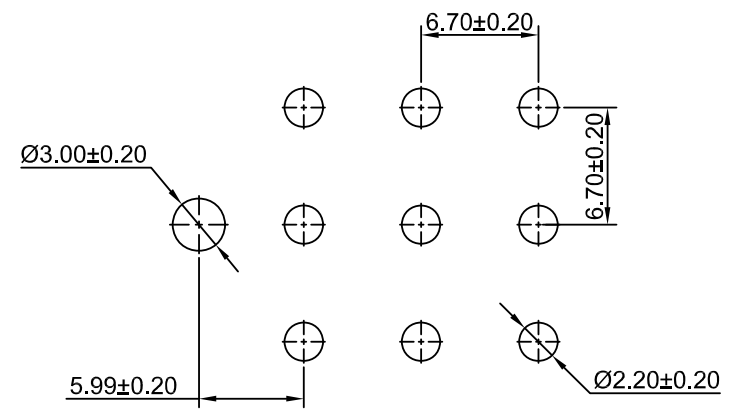
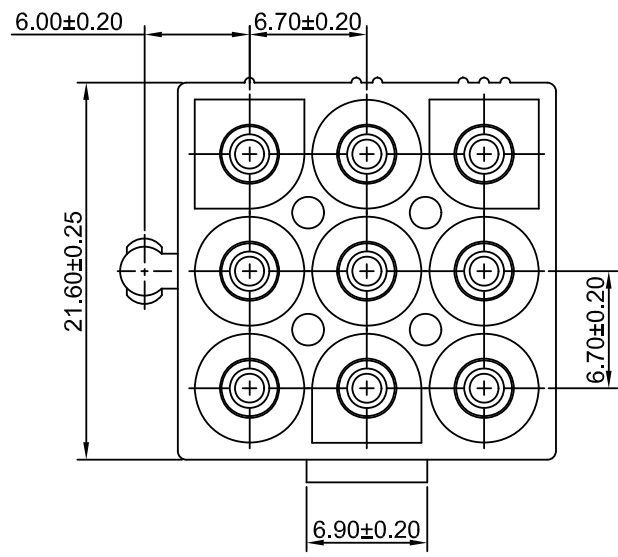

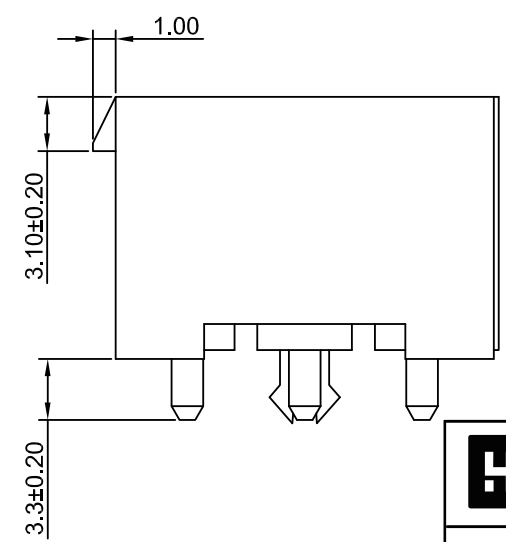
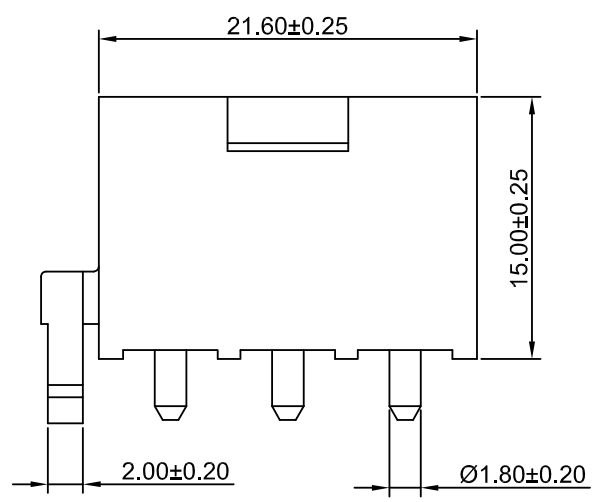

P.C.B LAYOUT



SPECIFICATIONS:
 Current Rating: 8A AC,DC
 Voltage Rating: 600V AC,DC
 Temperature Range: -25°C ~ +85°C
 Contact Resistance: 20mΩ Max.
 Insulation Resistance: 1000MΩ Min.
 Withstanding Voltage: 5000V AC/minute
 Pin Material: Brass/Tin Over Nickel
 Material: Nylon 66 UL94V-2(Natural)

 深圳市华德共创科技有限公司 SHENZHEN HUADE CO-CREATE TECHNOLOGY CO.,LTD TEL : 0755-27129737 FAX : 0755-29940187				TITLE: 6.70mm Pitch Housing 产品名称: Housing							
				PART NO: HDGC6701WV-3x3P 产品编号:							
X.X ±0.30 X.X° ±3°		APPD: 核准: XIE		DATE: 2015-05-16		SCALE: 2:1		UNIT: mm		CODE NUMBER: A008	
X.XX ±0.30 X.XX° ±2°		CHECK: 校对: WANG		DATE: 2015-05-16		SCALE: 2:1		UNIT: mm		CODE NUMBER: A008	
X.XXX ±0.10 X.XXX° ±1°		DRAW: 绘图: WANG		DATE: 2015-05-16		SCALE: 2:1		UNIT: mm		CODE NUMBER: A008	

-TOLERANCES- UNLESS OTHERWISE SPECIFIED 公差参数表				 		TITLE: 6.70mm Pitch Housing 产品名称: Housing					
X.X	±0.30	X.X°	±3°	APPD: 核准:	XIE	PART NO: 产品编号: HDGC6701WV-3x3P					
X.XX	±0.30	X.XX°	±2°	CHECK: 校对:	WANG	DATE	SCALE	UNIT	CODE NUMBER		
X.XXX	±0.10	X.XXX°	±1°	DRAW: 绘图:	WANG	2015-05-16	2:1	mm	A008		