

修订 REV	标记 MARK	修改摘要 REVISION DESCRIPTION	签名 SIGNATURE	日期 DATE
AO		NEW RELEASE	WANG	2017-11-11

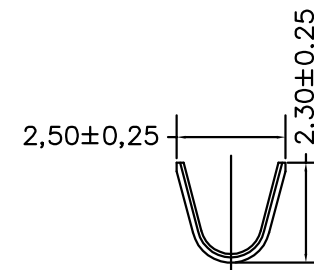

SECTION A-A

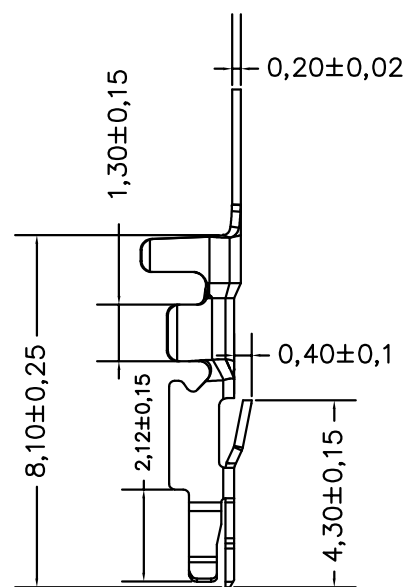
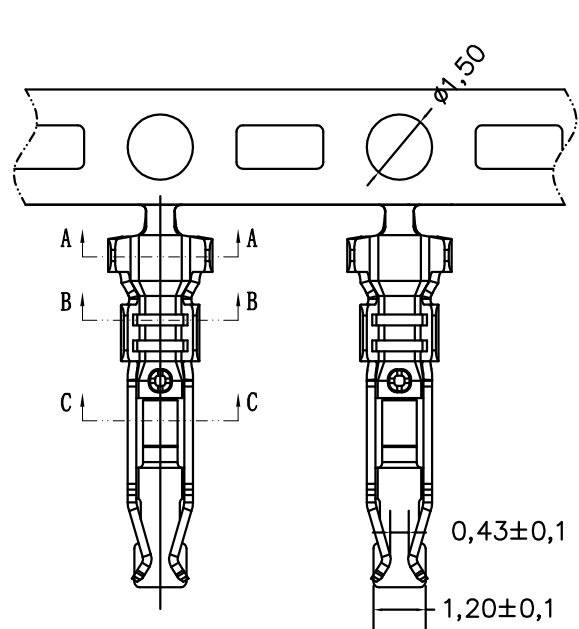
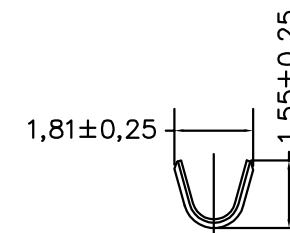

SECTION B-B

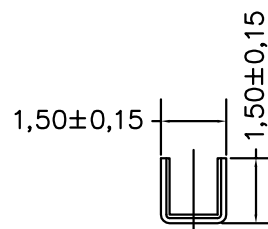

SECTION C-C

产品要求:
1. 材质要求: 磷铜C5191, 材厚: $T=0.20 \pm 0.02$ MM.



深圳市华德共创科技有限公司

Shenzhen Huade co-create Technology Co.,LTD

TEL : 0755-27129737 FAX : 0755-29940187

-TOLERANCES- UNLESS OTHERWISE SPECIFIED 公差参数表						TITLE: 2.50mm Pitch 产品名称: Crimp Terminal			
X.X	± 0.30	X.X°	$\pm 3^\circ$	APPD: 核准:	XIE	PART NO: 产品编号: HDGC2522-T			
X.XX	± 0.30	X.XX°	$\pm 2^\circ$	CHECK: 校对:	WANG	DATE	SCALE	UNIT	CODE NUMBER
X.XXX	± 0.10	X.XXX°	$\pm 1^\circ$	DRAW: 绘图:	WANG	2017-11-11	1:1	mm	A001

修订 REV	标记 MARK	修改摘要 REVISION DESCRIPTION	签名 SIGNATURE	日期 DATE
AO		NEW RELEASE	WANG	2017-11-11

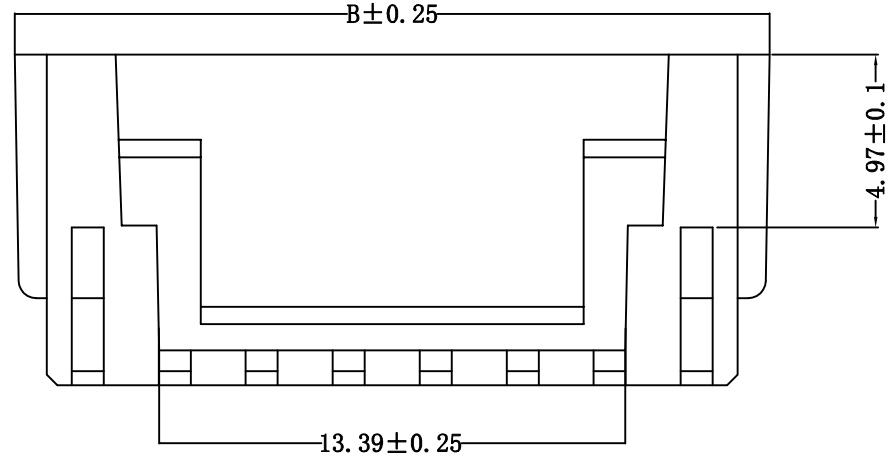
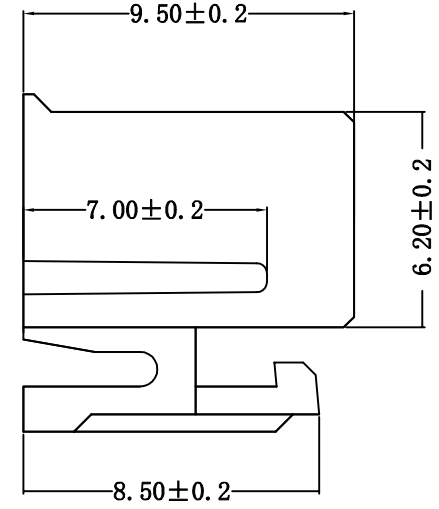
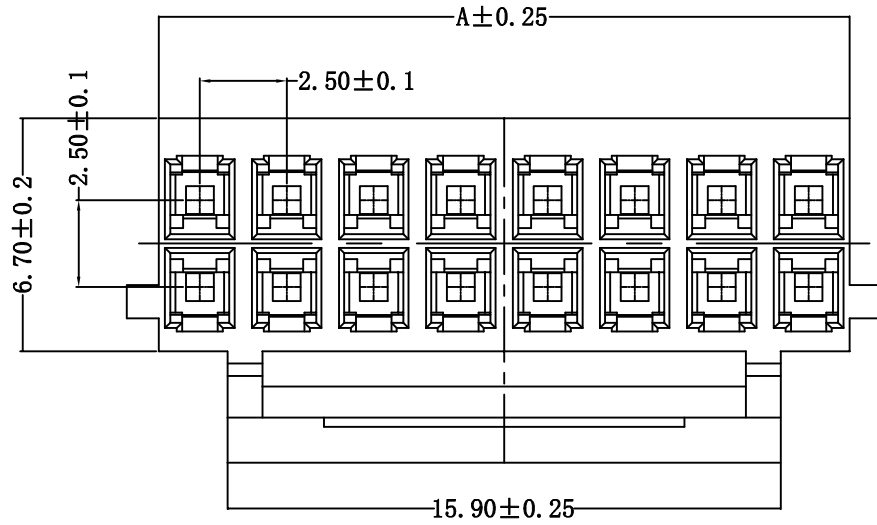

3	2X10P	24.85	26.70
2	2X9P	22.35	24.20
1	2X8P	19.85	21.70
序号	品名	A	B
		尺寸(mm)	

产品要求:

- 1、材质: PA66 黑色
UL94-V0。

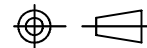

深圳市华德共创科技有限公司
Shenzhen Huade co-create Technology Co.,LTD
TEL : 0755-27129737 FAX : 0755-29940187

-TOLERANCES- UNLESS OTHERWISE SPECIFIED 公差参数表						TITLE: 产品名称: 2.50mm Pitch Housing			
X.X	±0.30	X.X°	±3°	APPD: 核准:	XIE	PART NO: 产品编号: HDGC2522H-2xXP			
X.XX	±0.30	X.XX°	±2°	CHECK: 校对:	WANG	DATE	SCALE	UNIT	CODE NUMBER
X.XXX	±0.10	X.XXX°	±1°	DRAW: 绘图:	WANG	2017-11-11	1:1	mm	A001