

修订 REV	标记 MARK	修改摘要 REVISION DESCRIPTION	签名 SIGNATURE	日期 DATE
AO		NEW RELEASE	WANG	2013-02-07

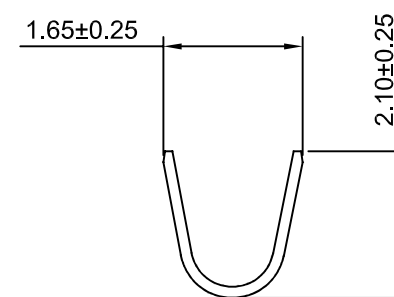

SEC:A-A

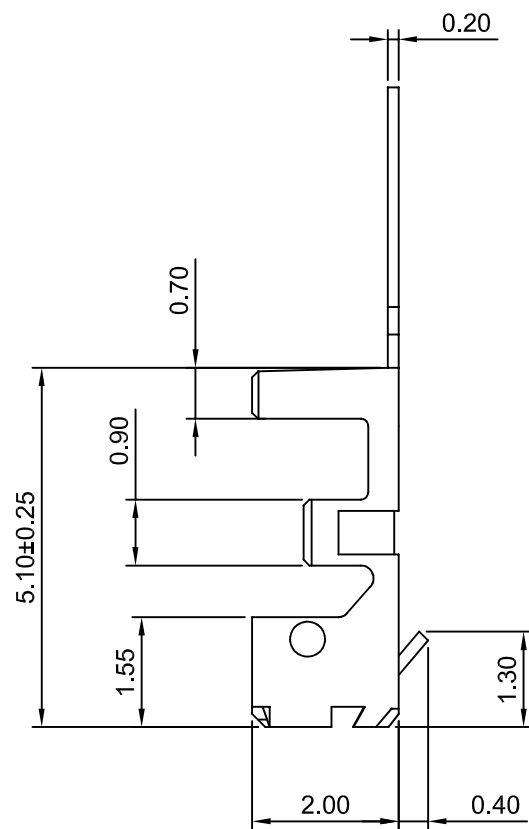
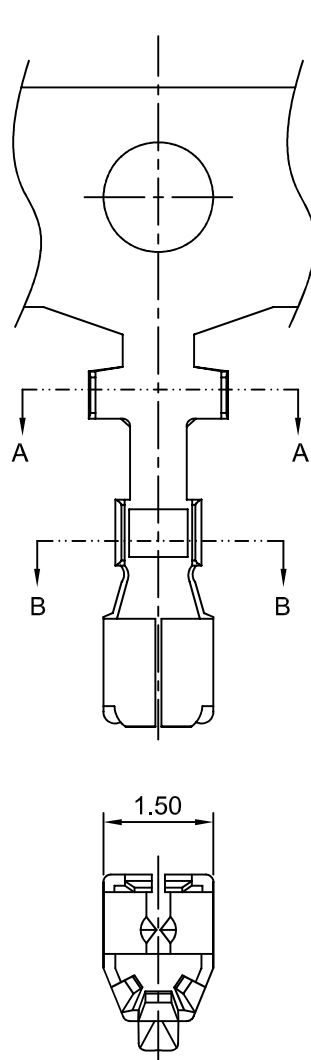
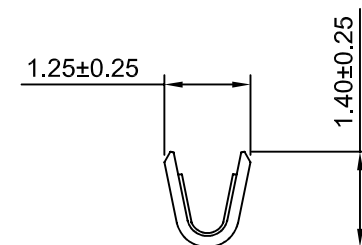

SEC:B-B

Ordering information & Specifications

Unit:mm

Part No	Wire Range	Insultion O.D.	Material	Finish	Qty/reel
HDGC2004-TP	AWG#24-#28	1.40mm(max)	Phosphor Bronze	Tin over Nickel	10,000 PCS
HDGC2004-GP	AWG#24-#28	1.40mm(max)	Phosphor Bronze	Gold over Nickel	10,000 PCS

Optional Gold plating available but MOQ requested



深圳市华德共创科技有限公司

Shenzhen Huade co-create Technology Co.,LTD

TEL : 0755-27129737 FAX : 0755-29940187

-TOLERANCES- UNLESS OTHERWISE SPECIFIED 公差参数表				TITLE: 产品名称: 2.00mm Pitch Crimp Terminal	
X.X	±0.30	X.X°	±3°	APPD: 核准: XIE	PART NO: 产品编号: HDGC2004-T
X.XX	±0.30	X.XX°	±2°	CHECK: 校对: WANG	DATE
X.XXX	±0.10	X.XXX°	±1°	DRAW: 绘图: WANG	SCALE
					UNIT
					CODE NUMBER
					A008

修订 REV	标记 MARK	修改摘要 REVISION DESCRIPTION	签名 SIGNATURE	日期 DATE
AO		NEW RELEASE	WANG	2013-02-07

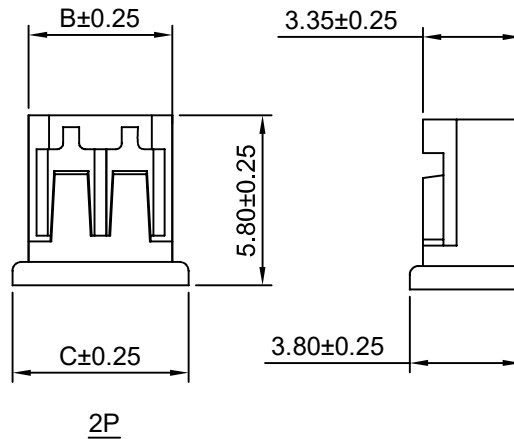
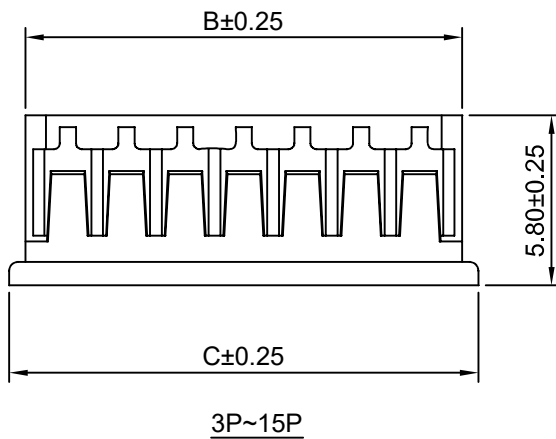
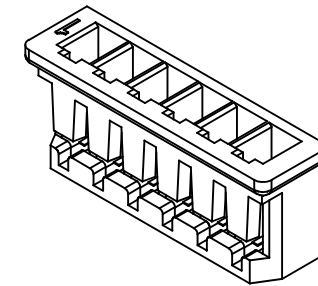
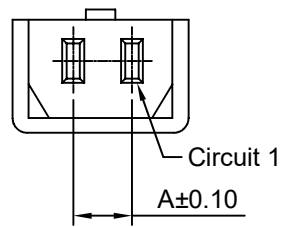
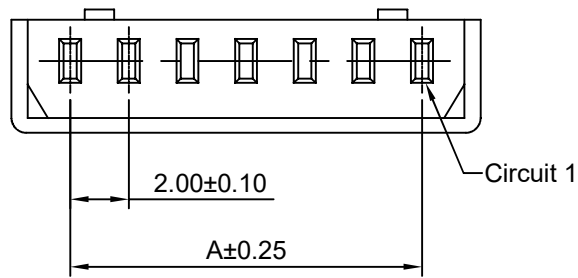

Ordering Information & Dimensions

Circuits	Dimensions(mm)			Circuits	Dimensions(mm)		
	A	B	C		A	B	C
2P	2.00	4.90	6.00	9P	16.00	18.90	20.00
3P	4.00	6.90	8.00	10P	18.00	20.90	22.00
4P	6.00	8.90	10.00	11P	20.00	22.90	24.00
5P	8.00	10.90	12.00	12P	22.00	24.90	26.00
6P	10.00	12.90	14.00	13P	24.00	26.90	28.00
7P	12.00	14.90	16.00	14P	26.00	28.90	30.00
8P	14.00	16.90	18.00	15P	28.00	30.90	32.00

SPECIFICATIONS:

Current Rating: 2A AC,DC
Voltage Rating: 125V AC,DC
Temperature Range: -25°C ~ +85°C
Contact Resistance: 20mΩ Max.
Insulation Resistance: 1000MΩ Min.
Withstanding Voltage: 800V AC/minute
Material: Nylon 66,UL94V-0(White)



深圳市华德共创科技有限公司

Shenzhen Huade co-create Technology Co.,LTD
TEL : 0755-27129737 FAX : 0755-29940187

-TOLERANCES- UNLESS OTHERWISE SPECIFIED 公差参数表						TITLE: 产品名称: 2.00mm Pitch Housing			
X.X	±0.30	X.X°	±3°	APPD: 核准:	XIE	PART NO: 产品编号: HDGC2004H-XP			
X.XX	±0.30	X.XX°	±2°	CHECK: 校对:	WANG	DATE	SCALE	UNIT	CODE NUMBER
X.XXX	±0.10	X.XXX°	±1°	DRAW: 绘图:	WANG	2013-02-07	4:1	mm	A008

修订 REV	标记 MARK	修改摘要 REVISION DESCRIPTION	签名 SIGNATURE	日期 DATE
AO		NEW RELEASE	WANG	2013-02-07

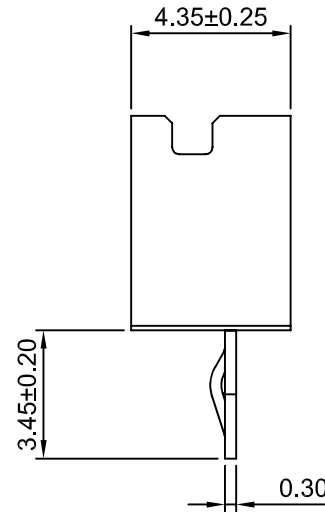
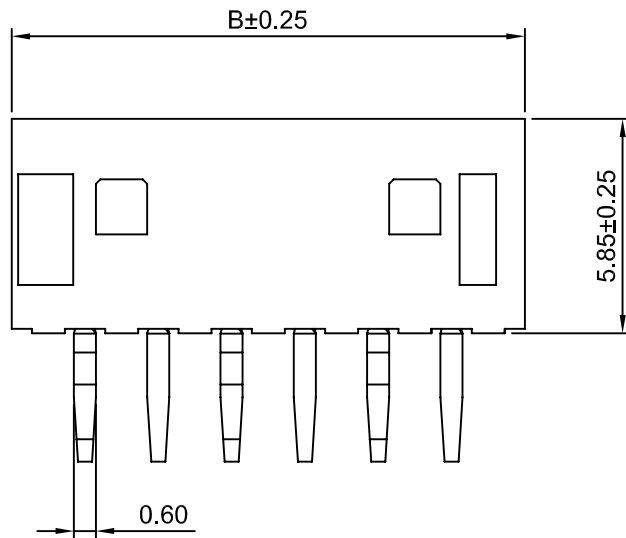
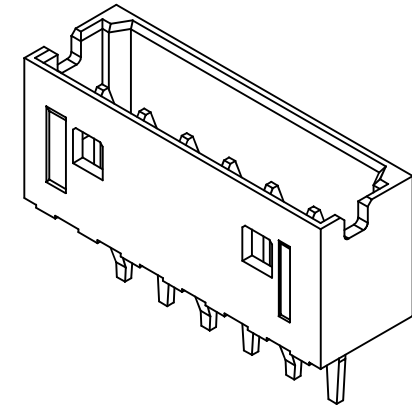
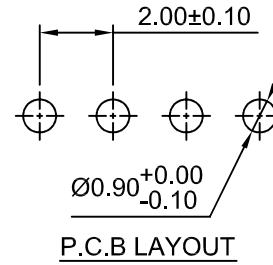
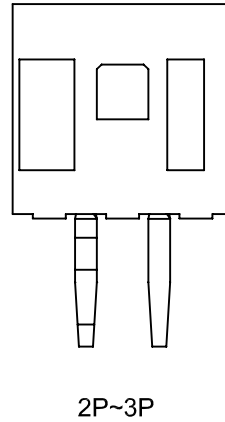
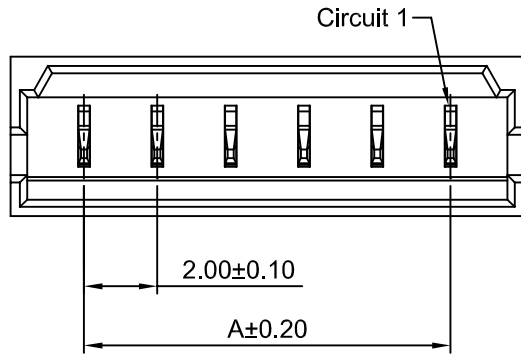

Ordering Information & Dimensions

Circuits	Dimensions(mm)		Circuits	Dimensions(mm)	
	A	B		A	B
2P	2.00	6.00	9P	16.00	20.00
3P	4.00	8.00	10P	18.00	22.00
4P	6.00	10.00	11P	20.00	24.00
5P	8.00	12.00	12P	22.00	26.00
6P	10.00	14.00	13P	24.00	28.00
7P	12.00	16.00	14P	26.00	30.00
8P	14.00	18.00	15P	28.00	32.00

SPECIFICATIONS:

Current Rating: 2A AC,DC
Voltage Rating: 125V AC,DC
Temperature Range: -25°C ~ +85°C
Contact Resistance: 20mΩ Max.
Insulation Resistance: 1000MΩ Min.
Withstanding Voltage: 800V AC/minute
Pin Material: Phosphor Bronze/Tin over Nickel
Material: Nylon 66,UL94V-0(Ivory)



深圳市华德共创科技有限公司

Shenzhen Huade co-create Technology Co.,LTD
TEL : 0755-27129737 FAX : 0755-29940187

-TOLERANCES- UNLESS OTHERWISE SPECIFIED 公差参数表				TITLE: 产品名称 : 2.00mm Pitch 180° Wafer	
X.X	±0.30	X.X°	±3°	APPD: 核准 :	XIE
X.XX	±0.30	X.XX°	±2°	CHECK: 校对 :	WANG
X.XXX	±0.10	X.XXX°	±1°	DRAW: 绘图 :	WANG
PART NO: 产品编号 :		HDGC2004WV-XP			
DATE	SCALE	UNIT	CODE NUMBER		
2013-02-07	5:1	mm	A008		

修订 REV	标记 MARK	修改摘要 REVISION DESCRIPTION	签名 SIGNATURE	日期 DATE
AO		NEW RELEASE	WANG	2013-02-07

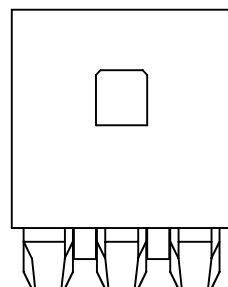
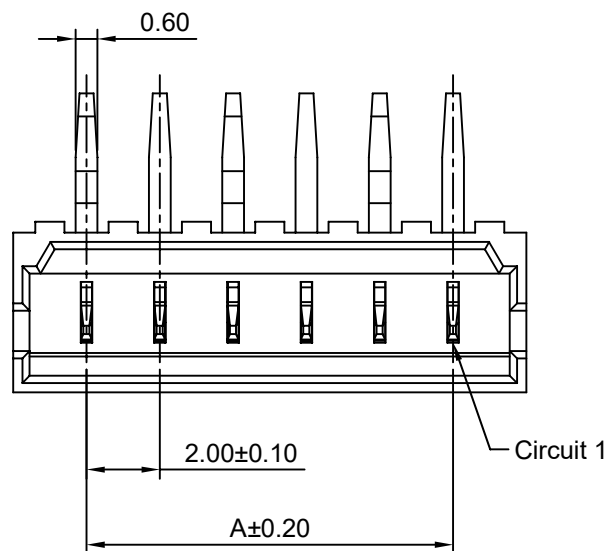

2P~3P

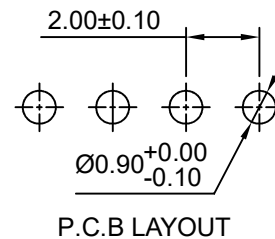

P.C.B LAYOUT

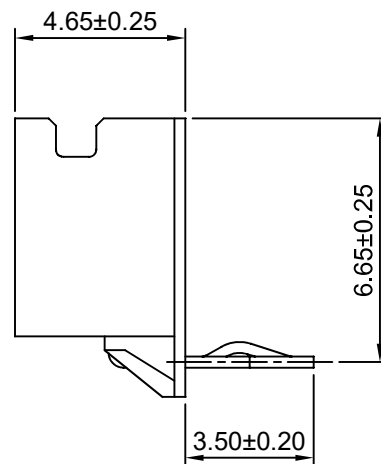
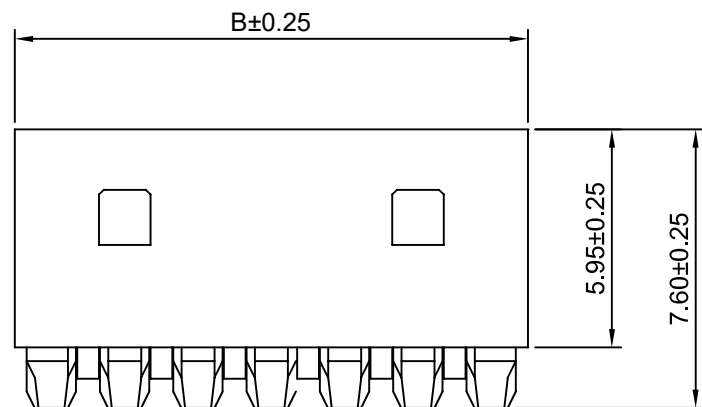
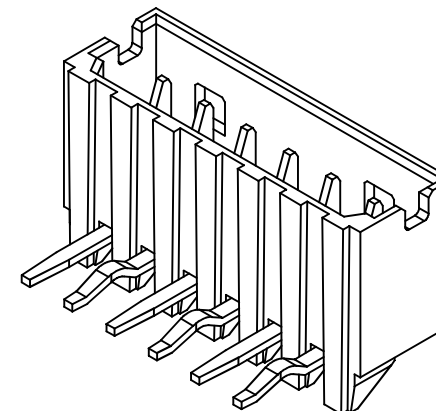

Ordering Information & Dimensions

Circuits	Dimensions(mm)		Circuits	Dimensions(mm)	
	A	B		A	B
2P	2.00	6.00	9P	16.00	20.00
3P	4.00	8.00	10P	18.00	22.00
4P	6.00	10.00	11P	20.00	24.00
5P	8.00	12.00	12P	22.00	26.00
6P	10.00	14.00	13P	24.00	28.00
7P	12.00	16.00	14P	26.00	30.00
8P	14.00	18.00	15P	28.00	32.00

SPECIFICATIONS:

Current Rating: 2A AC,DC
Voltage Rating: 125V AC,DC
Temperature Range: -25°C ~ +85°C
Contact Resistance: 20mΩ Max.
Insulation Resistance: 1000MΩ Min.
Withstanding Voltage: 800V AC/minute
Pin Material: Phosphor Bronze/Tin over Nickel
Material: Nylon 66,UL94V-0(White)



深圳市华德共创科技有限公司

Shenzhen Huade co-create Technology Co.,LTD

TEL : 0755-27129737 FAX : 0755-29940187

-TOLERANCES- UNLESS OTHERWISE SPECIFIED 公差参数表				TITLE: 产品名称: 2.00mm Pitch 90° Wafer	
X.X	±0.30	X.X°	±3°	APPD: 核准:	XIE
X.XX	±0.30	X.XX°	±2°	CHECK: 校对:	WANG
X.XXX	±0.10	X.XXX°	±1°	DRAW: 绘图:	WANG
PART NO: 产品编号:		HDGC2004WR-XP			
DATE	SCALE	UNIT	CODE NUMBER		
2013-02-07	5:1	mm	A008		