

修订 REV	标记 MARK	修改摘要 REVISION DESCRIPTION	签名 SIGNATURE	日期 DATE
AO		NEW RELEASE	WANG	2011-05-10

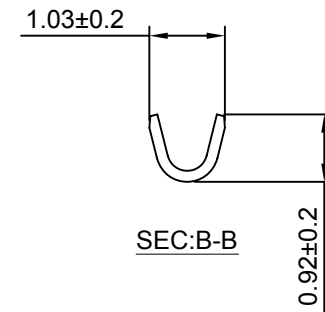
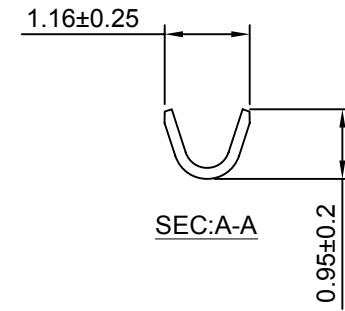
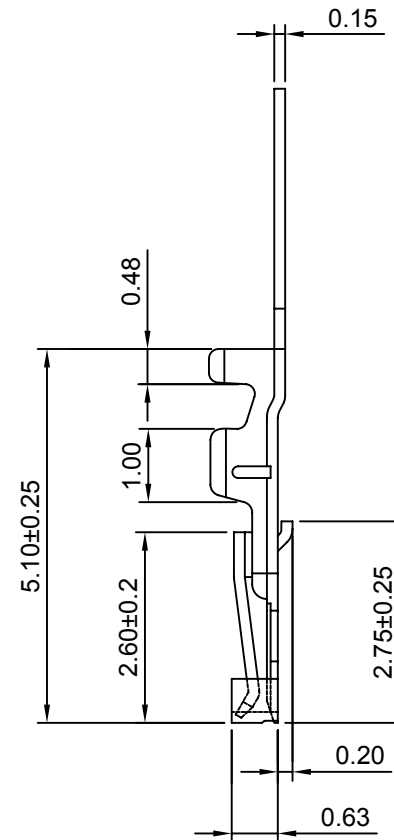
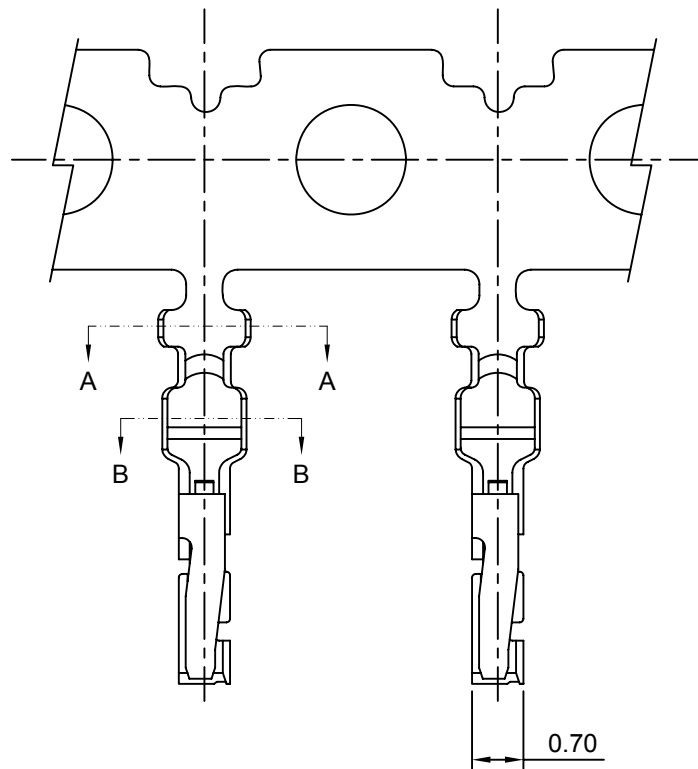

Ordering information & Specifications

Unit:mm

Part No	Wire Range	Insulation O.D.	Material	Finish	Qty/reel
HDGC1004-GP	AWG#28-#32	0.60mm(max)	Phosphor Bronze	Gold over Nickel	15,000 PCS



深圳市华德共创科技有限公司

Shenzhen Huade co-create Technology Co.,LTD

TEL : 0755-27129737

FAX : 0755-29940187

-TOLERANCES-
UNLESS OTHERWISE SPECIFIED
公差参数表

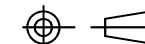

TITLE: 1.00mm Pitch
产品名称: Crimp Terminal

X.X ±0.30 X.X° ±3°

APPD:
核准: XIE

PART NO:
产品编号: HDGC1004-T

X.XX ±0.30 X.XX° ±2°

CHECK:
校对: WANG

DATE SCALE UNIT CODE NUMBER

X.XXX ±0.10 X.XXX° ±1°

DRAW:
绘图: WANG

2011-05-10 10:1 mm A008

修订 REV	标记 MARK	修改摘要 REVISION DESCRIPTION	签名 SIGNATURE	日期 DATE
AO		NEW RELEASE	WANG	2011-05-10

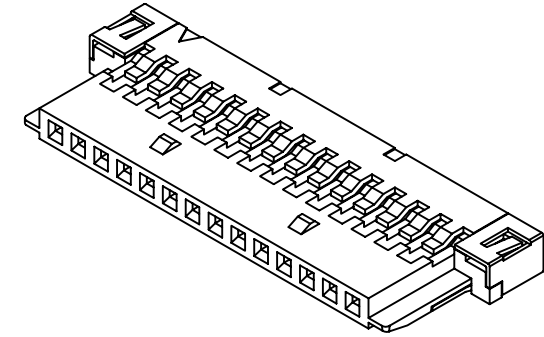
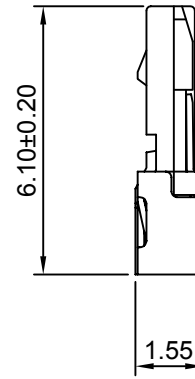
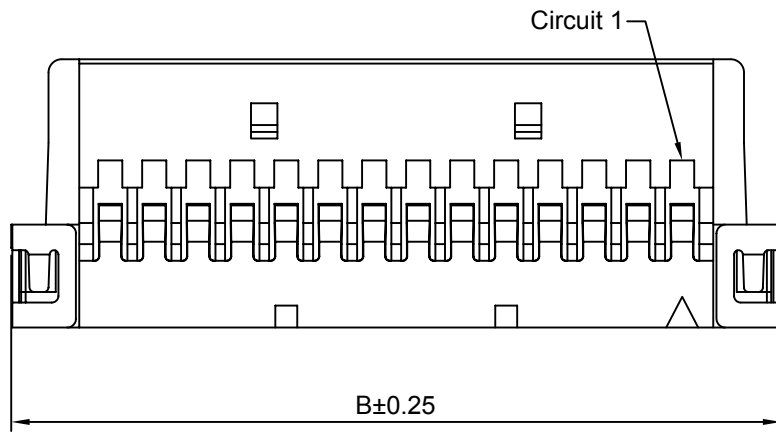
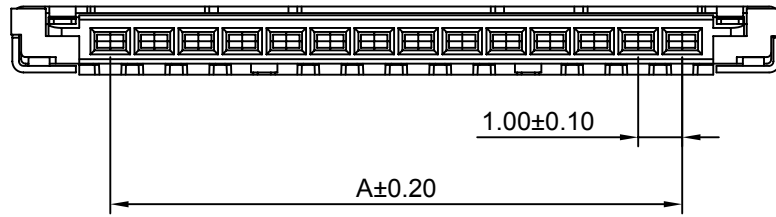

Ordering Information & Dimensions

Circuits	Dimensions(mm)		Circuits	Dimensions(mm)	
	A	B		A	B
8P	7.00	11.50	20P	19.00	23.50
14P	13.00	17.50	30P	29.00	33.50

SPECIFICATIONS:

Current rating: 1A AC,DC
Voltage rating: 100V AC,DC
Temperature range: -25°C ~ +85°C
Contact resistance: 30MΩ Max.
Insulation resistance: 500MΩ Min.
Withstanding voltage: 500V AC/minute
Material: Housing: Nylon 66,UL94V-0(Ivory)



深圳市华德共创科技有限公司

Shenzhen Huade co-create Technology Co.,LTD
TEL : 0755-27129737 FAX : 0755-29940187

-TOLERANCES- UNLESS OTHERWISE SPECIFIED 公差参数表						TITLE: 产品名称: 1.00mm Pitch Housing			
X.X	±0.30	X.X°	±3°	APPD: 核准:	XIE	PART NO: 产品编号: HDGC1004H-XP			
X.XX	±0.30	X.XX°	±2°	CHECK: 校对:	WANG	DATE	SCALE	UNIT	CODE NUMBER
X.XXX	±0.10	X.XXX°	±1°	DRAW: 绘图:	WANG	2011-05-10	6:1	mm	A008

修订 REV	标记 MARK	修改摘要 REVISION DESCRIPTION	签名 SIGNATURE	日期 DATE
A0		NEW RELEASE	WANG	2011-05-10

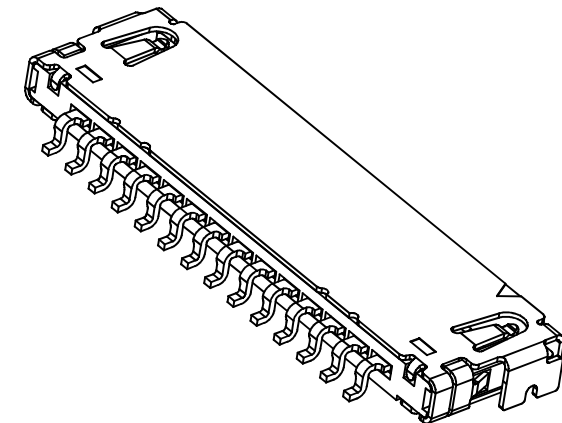
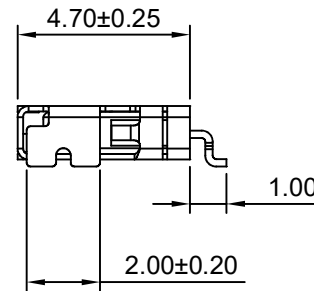
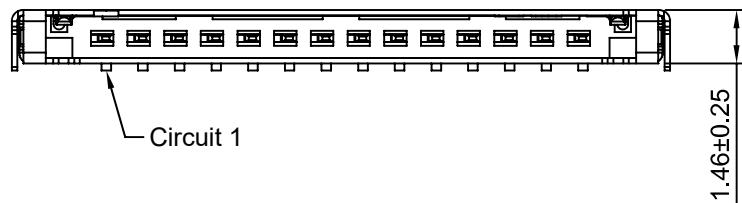
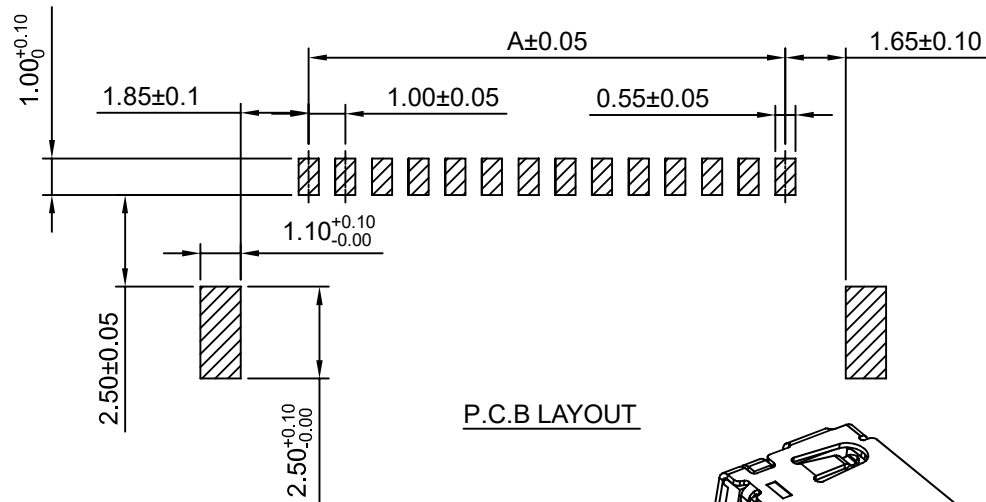
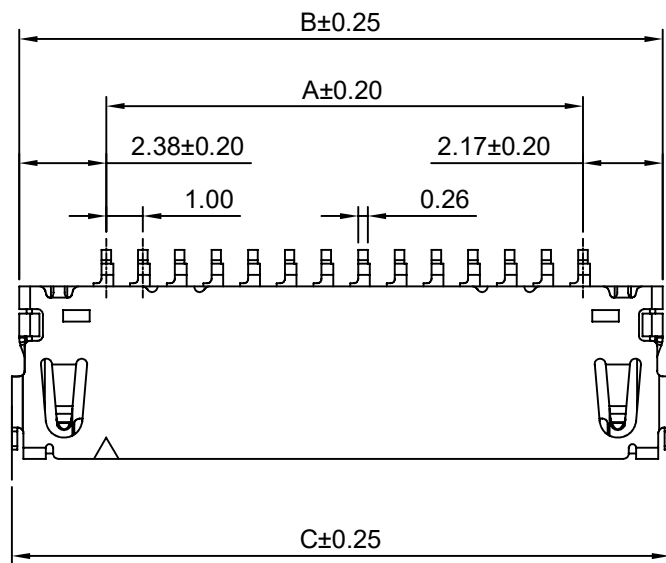

SPECIFICATIONS:

Current rating: 1A AC,DC
Voltage rating: 100V AC,DC
Temperature range: -25°C ~ +85°C
Contact resistance: 30MΩ Max.
Insulation resistance: 500MΩ Min.
Withstanding voltage: 500V AC/minute
Material: Pin: Phosphor Bronze/Gold over Nickel
Shell: Phosphor Bronze/Tin over Nickel
Material: Housing: Nylon 66, UL94V-0(Ivory)

Ordering Information & Dimensions

Circuits	Dimensions(mm)			Circuits	Dimensions(mm)		
	A	B	C		A	B	C
8P	7.00	11.55	11.95	20P	19.00	23.55	23.95
14P	13.00	17.55	17.95	30P	29.00	33.55	33.95



深圳市华德共创科技有限公司

Shenzhen Huade co-create Technology Co.,LTD
TEL : 0755-27129737 FAX : 0755-29940187

-TOLERANCES- UNLESS OTHERWISE SPECIFIED 公差参数表						TITLE: 1.00mm Pitch 产品名称: 90° Wafer			
X.X	±0.30	X.X°	±3°	APPD: 核准:	XIE	PART NO: 产品编号: HDGC1004WR-S-XP			
X.XX	±0.30	X.XX°	±2°	CHECK: 校对:	WANG	DATE	SCALE	UNIT	CODE NUMBER
X.XXX	±0.10	X.XXX°	±1°	DRAW: 绘图:	WANG	2011-05-10	3:1	mm	A008